

---

# SERVICE MANUAL

---

SOLID-STATE AM/FM STEREOPHONIC TUNER AMPLIFIER

---

SANSUI MODEL 400

---

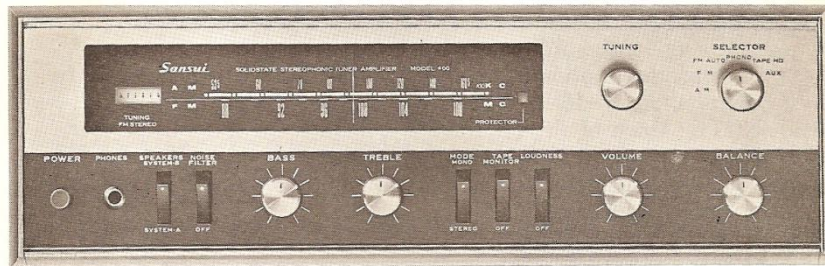

*Sansui*<sup>®</sup>

SANSUI ELECTRIC COMPANY LIMITED

**SANSUI**  
**SOLID-STATE**  
**am/fm-multiplex**  
**STEREO TUNER AMPLIFIER**



**MODEL-400**

**HOW TO USE THIS SERVICE MANUAL**

1. Look up the type of trouble you are confronted with in either the General Troubleshooting charts provided in this manual from pp 2-11.
2. By referring to the charts, isolate the trouble to a particular unit or part. (See the column titled "What To Do" in the General Chart and "Check Point" in the Troubleshooting Chart)
3. Locate the section of the chassis (Parts Layout P. 13), in which the part is located by using the co-ordinates (Column D) in the Parts List pp. 25-29.
4. Using the co-ordinates given in the Parts List (Column C), pinpoint the position of the part in the Schematic Diagram of Circuits, pp. 15-16.

NOTE: Much of the information contained in this manual has been prepared for use by qualified service repairmen. Please read your Warranty thoroughly before attempting any internal adjustments on your own.

**CONTENTS**

---

GENERAL CHART .....	2, 3
TROUBLESHOOTING CHART .....	4, 5, 6, 7, 8, 9, 10, 11
OVER ALL PROGRAM SOURCES .....	4, 5
AM RECEPTION .....	6, 7
FM MPX STEREO RECEPTION .....	7, 8, 9
FOR USE WITH A RECORD PLAYER (MAGNETIC) OR A TAPE DECK .....	10, 11
OTHER PROGRAM SOURCES .....	11
RECORDING ON TAPE .....	11
GENERAL DISASSEMBLY PROCEDURE	
BOTTOM PLATE/DIAL MECHANISM .....	12
PARTS LAYOUT .....	13
BLOCK DIAGRAM OF PRINTED CIRCUITS .....	14
SCHEMATIC DIAGRAM OF CIRCUITS .....	15, 16
SELECTOR SWITCH CHART .....	17
ALIGNMENT .....	18, 19, 20, 21
PRINTED-CIRCUIT SHEETS .....	22, 23, 24
PARTS LIST .....	25, 26, 27, 28, 29
COLOR CODE .....	30

# GENERAL CHART

If the amplifier is otherwise operating satisfactorily, the more common causes of trouble may generally be attributed to the following:

1. Incorrect connections or loose terminal contacts. Check the speakers, record player, tape recorder, antenna and line cord.
2. Improper operation.

Before operating any audio component, be sure to the

manufacturer's instructions.

3. Improper location of audio components. The proper positioning of components, such as speakers and turntable, is vital to stereo.
4. Defective audio components.

The following are some other common causes of malfunction and what to do about them.

PROGRAM	SYMPTOM	PROBABLE CAUSE	WHAT TO DO
AM, FM or FM-MPX reception	A. Constant or intermittent noise heard at certain times or in a certain area	<ul style="list-style-type: none"> <li>* Discharge or oscillation caused by electrical appliances, such as fluorescent lamp, TV set, A.C. motor, rectifier and oscillator</li> <li>* Natural phenomena, such as atmospheric conditions, statics and thunderbolts</li> <li>* Insufficient antenna input due to reinforced concrete walls of or long distance from the broadcasting station</li> <li>* Wave interference from other electrical appliances</li> </ul>	<ul style="list-style-type: none"> <li>* Attach a noise limiter to the electrical appliance that causes the noise, or attach it to the power source of the amplifier</li> <li>* Install an outdoor antenna and ground the amplifier to raise the signal-to-noise ratio</li> <li>* Reverse the power cord plug-receptacle connections</li> <li>* If the noise occurs at a certain frequency, attach a wave trap to the ANT. input</li> <li>* Keep the set at a proper distance from other electrical appliances</li> </ul>
	B. The needle of the tuning indicator does not move well.	See Operating Instructions Manual, "Tuning Indicator" for explanation	Tune the set for maximum signal strength
AM reception	A. Noise heard at a particular time of a day, in a certain area or over part of the dial	Natural phenomenon of AM reception	<ul style="list-style-type: none"> <li>* Install an antenna for maximum antenna efficiency. See "ANTENNA" in the Operating Instructions manual</li> <li>* In some cases, the noise can be eliminated by grounding the amplifier or reversing the power cord plug-receptacle connections</li> </ul>
	B. High-frequency noise	<ol style="list-style-type: none"> <li>1. Adjacent-channel interference or beat interference</li> <li>2. TV set too close to the audio system</li> </ol>	<ul style="list-style-type: none"> <li>* Although such noise cannot be eliminated by the amplifier, it is advisable to turn the TREBLE control properly from midpoint to left and switch on the NOISE FILTER</li> <li>* Keep the TV set at a proper distance from the audio system</li> </ul>
FM reception	A. Noisy	<p>Poor noise limiter effect or too low S/N ratio due to insufficient antenna input</p> <p>Note: FM reception is affected considerably by the broadcasting station's power and antenna efficiency. As a result, you may receive one station quite well while having difficulty in receiving another station.</p>	<ul style="list-style-type: none"> <li>* Install an antenna (provided) for maximum signal strength</li> <li>* If this is not effective, use an outdoor antenna designed exclusively for FM. When you use a TV antenna for both TV and FM with the help of a divider, make sure the TV reception is not affected</li> <li>* An excessively long antenna may cause noise</li> </ul>



# GENERAL CHART

PROGRAM	SYMPTOM	PROBABLE CAUSE	WHAT TO DO
FM reception (continued)	B. Emission of a scratching sound	* Ignition noise caused by the starting of an automobile engine	* Install the antenna and its lead-in wire at a proper distance from the road or raise the antenna input as previously described.
	C. Distortion or no sound during the reception	* Tuning drift results from the nature of FM	The built-in automatic frequency control prevents distortion during FM reception. If the FM program should be out of tune due to mechanical vibration or other factors, retune it.
	D. Tuning noise between stations	* This noise results from the nature of FM reception. As the station signal becomes weak, the noise limiter effect is also decreased. The amplification of the limiter, in turn, is enlarged and emits a larger noise	The unit is not at fault. Reduce the sound level before turning the TUNING knob.
FM-MPX stereo reception	A. Noise heard during FM-MPX stereo reception while not heard during FM mono reception	* Weaker signal because the service area of the FM-MPX broadcast is only half that of the FM mono broadcast	* Install an antenna for maximum antenna input * Switch on the NOISE FILTER and/or turn the TREBLE control properly from midpoint to left
	B. Clearness of channel separation is decreased during the reception	* Improper ventilation. Air circulation is important to the amplifier's performance	* Make sure that air can flow above and below the unit
	C. The stereo indicator goes on and off	* Interference. The indicator is not at fault.	Adjust VR <sub>102</sub>
	D. The stereo indicator goes on and off even though a stereo station is not received	* Interference. The indicator is not at fault.	Adjust VR <sub>502</sub>
Record or tape playing	A. Hum or howling	* Record player placed directly on the speaker box * Use of wire other than shielded wire * Loose terminal contact * Shielded wire too close to the line cord, fluorescent lamp or other electrical appliances * Nearby amateur radio station or TV transmission antenna	* Put a cushion between the player and the speaker box or separate them entirely * The connecting cord should be as short as possible * Reduce the bass loudness properly  * Consult the nearest Radio Regulatory Bureau
	B. Surface noise	* Worn or old record * Worn pick-up needle * Needle covered with dust * Improper needle pressure	* Turn the TREBLE control properly from midpoint to left * Switch on the NOISE FILTER * Use the pick-up correctly
Over all stereo programs	The BALANCE control is not at the midpoint when equal sound comes from left and right channels	* The BALANCE control should not be always set at midpoint	* Set the control to the position where equal sound comes from both channels * Check for unequal program loudness



# TROUBLESHOOTING CHART

## OVER ALL PROGRAM SOURCES

SYMPTOM	PROBABLE CAUSE		CHECK POINT
No sound over all program sources	A. Defective speaker	<ol style="list-style-type: none"> <li>1. Broken speaker cord</li> <li>2. Broken or short-circuited voice coil</li> </ol>	Check continuity of speaker and cord Repair broken cord or replace speaker
	B. No power	<ol style="list-style-type: none"> <li>1. No power comes to the power source</li> <li>2. Defective on-off switch</li> <li>3. Defective power cord</li> <li>4. Loose plug contact</li> <li>5. Blown fuse If the fuse burns out as soon as it is replaced, the trouble may be attributed to: a. Shorted power transformer; b. Shorted capacitor; c. +B circuit open.</li> <li>6. Broken primary winding of power transformer</li> </ol>	S <sub>001</sub>  PV <sub>001</sub> F <sub>001</sub>  T <sub>001</sub> C <sub>001</sub> , C <sub>005</sub> Check voltage in B circuit by means of a tester  T <sub>001</sub>
	C. Defective power circuit	Divergence of voltage specified in "SCHEMATIC DIAGRAM OF CIRCUITS"	Measure voltage in power circuit and replace defective element
	D. Defective low-frequency circuit	<ol style="list-style-type: none"> <li>1. Divergence of voltage specified in "SCHEMATIC DIAGRAM OF CIRCUITS"</li> </ol> <p>Note: If the PROTECTOR indicator should light up, push the POWER switch OFF and after about 5 seconds push it ON. If the indicator should still light up, push it OFF again and check for shorting of speaker terminals and improper connections between them.</p> <ol style="list-style-type: none"> <li>2. Blown fuse If the fuse burns out as soon as it is replaced, the trouble may be attributed to: a. Defective main amplifier section b. Shorted power transistor c. Output terminals in contact with each other</li> <li>3. Defective transistor</li> <li>4. Electrolytic condenser, short or open</li> </ol>	Measure voltage in low-frequency circuit and replace defective element.          F <sub>001</sub> , F <sub>002</sub>   TR <sub>501</sub> ~TR <sub>502</sub> , TR <sub>503</sub> ~TR <sub>504</sub> ⊕ and ⊖ terminals of right and left channels Check voltage in each section. Check voltage in each section.
	E. Troubles other than electrical	<ol style="list-style-type: none"> <li>1. TAPE MONITOR switch in ON position</li> <li>2. Headphone plugged in jack</li> </ol>	Turn the TAPE MONITOR switch OFF. Remove the headphone plug.
Weak sound over all program sources	A. Defective speaker circuit	Shorted voice coil	Check voice coil for short circuit.

# TROUBLESHOOTING CHART

## OVER ALL PROGRAM SOURCES

SYMPTOM	PROBABLE CAUSE		CHECK POINT
Weak sound over all program sources (continued)	B. Defective power circuit	Divergence of voltage specified in "SCHEMATIC DIAGRAM OF CIRCUITS"	Measure voltage in power circuit and replace defective element
	C. Defective low-frequency circuit	<ol style="list-style-type: none"> <li>1. Divergence of voltage specified in "SCHEMATIC DIAGRAM OF CIRCUITS"</li> <li>2. Insufficient capacity or short-circuit of capacitor</li> <li>3. Aging transistor</li> </ol>	Measure voltage in low-frequency circuit and replace defective element  C <sub>701</sub> ~C <sub>734</sub> , C <sub>801</sub> , C <sub>802</sub>  TR <sub>801</sub> ~TR <sub>804</sub> , TR <sub>701</sub> ~TR <sub>710</sub> , TR <sub>801</sub> ~TR <sub>804</sub>
Distortion over all program sources	A. Defective speaker	<ol style="list-style-type: none"> <li>1. Defective voice coil</li> <li>2. Defective cone or damper</li> </ol>	Check and replace
	B. Defective power circuit	Divergence of voltage specified in "SCHEMATIC DIAGRAM OF CIRCUITS"	Measure voltage in power circuit and replace defective element
	C. Defective low-frequency circuit	<ol style="list-style-type: none"> <li>1. Divergence of voltage specified in "SCHEMATIC DIAGRAM OF CIRCUITS"</li> <li>2. Aging or weak transistor</li> </ol>	Measure voltage in low-frequency circuit and replace defective element  TR <sub>801</sub> ~TR <sub>804</sub> , TR <sub>701</sub> ~TR <sub>710</sub> , TR <sub>801</sub> ~TR <sub>804</sub>
Hum over all program sources	A. Defective power circuit	Insufficient capacity of capacitor	C <sub>001</sub> ~C <sub>004</sub> , C <sub>005</sub> , C <sub>006</sub> , C <sub>007</sub>
	B. Defective low-frequency circuit	<ol style="list-style-type: none"> <li>1. Insufficient capacity of capacitor</li> <li>2. Fixed resistor blown</li> </ol>	C <sub>001</sub> ~C <sub>004</sub> , C <sub>005</sub> R <sub>725</sub> , R <sub>726</sub> and other fixed resistors
Noise over all program sources	A. Defective speaker	<ol style="list-style-type: none"> <li>1. Defective voice coil</li> <li>2. Inner contact of speaker components</li> <li>3. Defective cone or damper</li> </ol>	
	B. Defective power circuit	Divergence of voltage specified in "SCHEMATIC DIAGRAM OF CIRCUITS"	Measure voltage in power circuit and replace defective element
	C. Defective low-frequency circuit	<ol style="list-style-type: none"> <li>1. Aging or weak transistor</li> <li>2. Defective master volume</li> </ol>	TR <sub>801</sub> ~TR <sub>804</sub> , TR <sub>701</sub> ~TR <sub>710</sub> , TR <sub>801</sub> ~TR <sub>804</sub> VR <sub>701</sub> ~VR <sub>704</sub>
SPEAKER switch does not work	A. Defective headphone		Check S <sub>6a</sub> and S <sub>6b</sub> speaker switches
Noise FILTER switch does not work	A. Defective filter circuit		C <sub>717</sub> , C <sub>718</sub> , S <sub>3a</sub> , S <sub>3b</sub>
LOUDNESS switch does not work	A. Defective loudness circuit		C <sub>010</sub> ~C <sub>013</sub> , R <sub>006</sub> , R <sub>007</sub> VR <sub>701</sub> , VR <sub>702</sub> , S <sub>40a</sub> , S <sub>40b</sub>
TONE CONTROL does not work	A. Defective tone control circuit	<ol style="list-style-type: none"> <li>1. Shorting or disconnection</li> <li>2. Improper wiring or defective resistor</li> <li>3. Defective VR</li> </ol>	C <sub>705</sub> ~C <sub>714</sub> R <sub>200</sub> ~R <sub>710</sub>  VR <sub>705</sub> ~VR <sub>708</sub>

## AM RECEPTION

SYMPTOM	PROBABLE CAUSE	CHECK POINT
No sound	A. Defective overall section	See "No sound over all program sources"
	B. Defective AM section <ol style="list-style-type: none"> <li>1. Divergence of voltage specified in "SCHEMATIC DIAGRAM OF CIRCUITS"</li> <li>2. Aging or defective transistor</li> <li>3. Aging or defective I.F.T.</li> <li>4. Detector diode defective</li> <li>5. Aging or defective capacitor</li> <li>6. Defective or broken coil</li> <li>7. Defective resistor</li> </ol>	Measure voltage in AM section and replace defective element  TR <sub>301</sub> ~TR <sub>303</sub> T <sub>302</sub> ~T <sub>305</sub> D <sub>301</sub> ~D <sub>303</sub> C <sub>302</sub> , C <sub>313</sub> , C <sub>314</sub> , C <sub>315</sub> , C <sub>318</sub> , C <sub>319</sub>
	C. Defective equalizer amplifier <ol style="list-style-type: none"> <li>1. Divergence of voltage specified in "SCHEMATIC DIAGRAM OF CIRCUITS"</li> <li>2. Shorted capacitor</li> <li>3. Broken resistor</li> <li>4. Loose contact of rotary switch</li> </ol>	Measure voltage in equalizer amplifier circuit and replace defective element  C <sub>601</sub> , C <sub>602</sub> , C <sub>604</sub> , C <sub>605</sub> , C <sub>606</sub> , C <sub>611</sub> , C <sub>612</sub> , C <sub>614</sub> , C <sub>615</sub> , C <sub>616</sub> R <sub>602</sub> ~R <sub>607</sub> , R <sub>615</sub> ~R <sub>621</sub> S <sub>1c</sub> ~S <sub>1h</sub>
Weak sound	A. Weak station signal	See "GENERAL CHART"
	B. Defective overall section	See "Weak sound over all program sources"
	C. Defective AM section <ol style="list-style-type: none"> <li>1. Divergence of voltage specified in "SCHEMATIC DIAGRAM OF CIRCUITS"</li> <li>2. Voltage drop in local oscillator</li> <li>3. Detector diode, aging or weak</li> <li>4. Too low Q of coil</li> <li>5. Insufficient capacity of capacitor</li> <li>6. Aging or weak resistor</li> <li>7. Divergence in adjustment of:               <ol style="list-style-type: none"> <li>a. Tracking</li> <li>b. I.F.T.</li> </ol> </li> </ol>	Measure Voltage in AM section and replace defective element  TR <sub>301</sub> , C <sub>306</sub> , C <sub>307</sub> , C <sub>305</sub> , C <sub>302</sub> , T <sub>301</sub> D <sub>302</sub> L <sub>301</sub> , T <sub>301</sub> ~T <sub>305</sub> C <sub>303</sub> , C <sub>304</sub> , C <sub>309</sub> ~C <sub>311</sub> R <sub>301</sub> , R <sub>306</sub> Use measuring instruments for optimum adjustment TC <sub>301</sub> , TC <sub>302</sub> , L <sub>301</sub> , T <sub>301</sub> T <sub>302</sub> ~T <sub>305</sub>
	D. Defective equalizer amplifier <ol style="list-style-type: none"> <li>1. Divergence or voltage specified in "SCHEMATIC DIAGRAM OF CIRCUITS"</li> <li>2. Insufficient capacity of capacitor</li> <li>3. Loose contact of rotary switch</li> </ol>	Measure voltage in equalizer amplifier circuit and replace defective element  C <sub>601</sub> , C <sub>603</sub> , C <sub>605</sub> , C <sub>606</sub> , C <sub>611</sub> , C <sub>613</sub> , C <sub>615</sub> , C <sub>616</sub> S <sub>1c</sub> ~S <sub>1h</sub>
Distortion	A. Defective overall section	See "Distortion over all program sources"



# TROUBLESHOOTING CHART

## AM RECEPTION

SYMPTOM	PROBABLE CAUSE		CHECK POINT
Distortion (continued)	B. Defective AM section	<ol style="list-style-type: none"> <li>1. Divergence of voltage specified in "SCHEMATIC DIAGRAM OF CIRCUITS"</li> <li>2. Detector diode, aging or weak</li> <li>3. Insufficient capacity of capacitor</li> <li>4. Divergence in adjustment</li> <li>5. Defective resistor</li> <li>6. Excessive antenna input</li> </ol>	Measure voltage in AM section and replace defective element  D <sub>301</sub> , D <sub>302</sub> C <sub>305</sub> , C <sub>315</sub> , C <sub>318</sub> , C <sub>319</sub> See "Weak sound"  Turn ANTENNA switch to DIST
	C. Defective equalizer amplifier	<ol style="list-style-type: none"> <li>1. Divergence of voltage specified in "SCHEMATIC DIAGRAM OF CIRCUITS"</li> <li>2. Capacitor, short or broken</li> <li>3. Defective resistor</li> <li>4. Defective transistor</li> </ol>	Measure voltage in equalizer amplifier circuit and replace defective element  C <sub>601</sub> , C <sub>603</sub> , C <sub>605</sub> , C <sub>606</sub> , C <sub>611</sub> , C <sub>613</sub> , C <sub>615</sub> , C <sub>616</sub> R <sub>602</sub> ~R <sub>612</sub> , R <sub>615</sub> ~R <sub>625</sub> TR <sub>601</sub> ~TR <sub>604</sub>
Hum	A. Defective overall section		See "Hum over all program sources"
	B. Defective AM section	Insufficient capacity of capacitor	C <sub>007</sub> , C <sub>008</sub> , C <sub>312</sub> , C <sub>316</sub> , C <sub>303</sub>
	C. Defective equalizer amplifier	Insufficient capacity of capacitor	C <sub>004</sub>
Noise	A. Amplifier is O.K.		See "GENERAL CHART"
	B. Defective overall section		See "Noisy over all program sources"
	C. Defective AM section	<ol style="list-style-type: none"> <li>1. Aging or defective transistor</li> <li>2. Loose contact of rotary switch</li> <li>3. Broken antenna lead or shorted variable capacitor</li> </ol>	TR <sub>301</sub> ~TR <sub>303</sub> , TR <sub>601</sub> ~TR <sub>604</sub> S <sub>1c</sub> ~S <sub>1h</sub> , S <sub>1j</sub> L <sub>301</sub> , VC <sub>301</sub>

## FM MPX STEREO RECEPTION

SYMPTOM	PROBABLE CAUSE		CHECK POINT
No sound	A. Defective overall section		See "No sound over all program sources"
	B. Defective FM or FM STEREO section	<ol style="list-style-type: none"> <li>1. Divergence of voltage specified in "SCHEMATIC DIAGRAM OF CIRCUITS"</li> <li>2. Defective transistor</li> <li>3. Disconnected resistor</li> </ol>	Measure voltage in FM or FM STEREO section and replace defective element  TR <sub>101</sub> ~TR <sub>103</sub> , TR <sub>201</sub> ~TR <sub>204</sub> , TR <sub>401</sub> , TR <sub>407</sub> , TR <sub>501</sub> ~TR <sub>505</sub> Check resistors in each circuit

## FM MPX STEREO RECEPTION

SYMPTOM	PROBABLE CAUSE	CHECK POINT
No sound (continued)	<ol style="list-style-type: none"> <li>4. Aging capacitor</li> <li>5. Defective IFT</li> <li>6. Broken coil</li> <li>7. Defective CR</li> <li>8. Defective local oscillator</li> </ol>	Check capacitors in each circuit $T_{101}, T_{201} \sim T_{204}, T_{401} \sim T_{403}$ $L_{101} \sim L_{103}, L_{201}, L_{401}, L_{402}$ $CR_{401}, CR_{402}$ $TR_{102}, C_{105}, C_{108}, C_{109}$
Weak sound	A. Weak station signal	See "GENERAL CHART"
	B. Defective overall section	See "Weak sound over all program sources"
	C. Defective FM or FM STEREO section <ol style="list-style-type: none"> <li>1. Divergence of voltage specified in "SCHEMATIC DIAGRAM OF CIRCUITS"</li> <li>2. Poor Q of coil</li> <li>3. Divergence adjustment of coil</li> <li>4. Insufficient capacity of capacitor</li> <li>5. Loose contact of rotary switch</li> <li>6. Aging transistor</li> <li>7. Aging diode</li> <li>8. Defective local oscillator</li> <li>9. Divergence in adjustment of:               <ol style="list-style-type: none"> <li>a. Tracking</li> <li>b. IFT</li> </ol> </li> </ol>	Measure voltage in FM or FM STEREO section and replace defective element $L_{101} \sim L_{103}, T_{101}, T_{201} \sim T_{204}$ $T_{401} \sim T_{405}$ Check capacitors in each circuit $S_{1b}, S_{1j}$ $TR_{101} \sim TR_{103}, TR_{201} \sim TR_{204}, TR_{401} \sim TR_{407}, TR_{501} \sim TR_{505}$ $D_{201} \sim D_{204}, D_{401} \sim D_{406}, D_{501} \sim D_{503}$ $TR_{102}, C_{108}, C_{110}, L_{103}$ Use measuring instruments for optimum adjustment $TC_{101} \sim TC_{103}, L_{101} \sim L_{103}$ $T_{101}, T_{201} \sim T_{204}, T_{401} \sim T_{403}$
Distortion	A. Defective overall section	See "Distortion over all program sources"
	B. Defective FM or FM STEREO section <ol style="list-style-type: none"> <li>1. Divergence of voltage specified in "SCHEMATIC DIAGRAM OF CIRCUITS"</li> <li>2. Defective diode</li> <li>3. Insufficient capacity of capacitor</li> <li>4. Transistor bias</li> <li>5. Divergence in adjustment of:               <ol style="list-style-type: none"> <li>a. Tracking</li> <li>b. IFT</li> <li>c. Multiplex coil</li> </ol> </li> </ol>	Measure voltage in FM or FM STEREO section and replace defective element $D_{203} \sim D_{206}, D_{403} \sim D_{406}$ Check capacitors in each circuit Check bias resistors in each circuit Use measuring instruments for optimum adjustment $TC_{101} \sim TC_{103}, L_{101} \sim L_{103}$ $T_{101}, T_{201} \sim T_{204}$ $T_{401} \sim T_{403}, VR_{401}$
Hum	A. Defective overall section	See "Hum over all program sources"
	B. Defective FM or FM STEREO section <ol style="list-style-type: none"> <li>Insufficient capacity of capacitor</li> </ol>	$C_{003}, C_{205}, C_{216}, C_{420}$

# TROUBLESHOOTING CHART

## FM MPX RECEPTION

SYMPTOM	PROBABLE CAUSE	CHECK POINT	
Noisy	A. Amplifier is O.K.	See "GENERAL CHART"	
	B. Defective overall section	See "Noise over all program sources"	
	C. Defective FM or FM STEREO section	<ol style="list-style-type: none"> <li>1. Divergence of voltage specified in "SCHEMATIC DIAGRAM OF CIRCUITS"</li> <li>2. Aging or weak transistor</li> <li>3. Defective multiplex coil</li> <li>4. Resistor, rubbing or blown</li> <li>5. Insufficient capacity of capacitor</li> <li>6. Malfunction of auto mechanism</li> <li>7. Loose contact of rotary switch</li> </ol>	Measure voltage in FM or FM-STEREO section and replace defective element TR <sub>101</sub> ~TR <sub>103</sub> , TR <sub>201</sub> ~TR <sub>204</sub> , TR <sub>401</sub> ~TR <sub>403</sub> T <sub>401</sub> ~T <sub>403</sub> Check resistors in each circuit C <sub>218</sub> , C <sub>418</sub> , C <sub>419</sub> , C <sub>421</sub> , C <sub>422</sub> , C <sub>425</sub> , C <sub>429</sub> , C <sub>431</sub> , C <sub>432</sub> TR <sub>501</sub> ~TR <sub>504</sub> , C and R S <sub>1b</sub> , S <sub>1j</sub>
No stereo sound (The STEREO indicator lamp does not glow orange)	A. Subcarrier amplifying circuit defective	<ol style="list-style-type: none"> <li>1. Divergence of voltage specified in "SCHEMATIC DIAGRAM OF CIRCUITS"</li> <li>2. Aging or weak transistor</li> <li>3. Aging or weak diode</li> <li>4. Defective multiplex coil</li> <li>5. Defective resistor</li> <li>6. Insufficient capacity or shorting of capacitor</li> <li>7. Divergence in adjustment of half-fixed resistor</li> <li>8. Divergence in adjustment of:               <ol style="list-style-type: none"> <li>a. FM stereo circuit</li> <li>b. Indicator circuit</li> </ol> </li> <li>9. Defective pilot lamp</li> </ol>	Measure voltage in subcarrier amplifying circuit (stereo indicator section) and replace defective element TR <sub>401</sub> ~TR <sub>407</sub> , TR <sub>501</sub> ~TR <sub>505</sub> D <sub>401</sub> ~D <sub>406</sub> , D <sub>501</sub> ~D <sub>503</sub> T <sub>401</sub> ~T <sub>403</sub> , T <sub>501</sub> R <sub>407</sub> ~R <sub>438</sub> , R <sub>501</sub> ~R <sub>511</sub> C <sub>406</sub> ~C <sub>432</sub> , C <sub>501</sub> ~C <sub>505</sub> VR <sub>401</sub> , VR <sub>501</sub> , VR <sub>502</sub> Use measuring instruments for optimum adjustment T <sub>401</sub> ~T <sub>403</sub> , T <sub>501</sub> PL <sub>501</sub>
Poor channel separation	A. Defective FM stereo section	<ol style="list-style-type: none"> <li>1. Same as above (1~8)</li> <li>2. Defective coil or diode in FM stereo section</li> </ol>	Check as above (1~8) Readjust or replace VR <sub>401</sub>
Stereo indicator changes in color between green and orange even when stereo program is not received	A. Amplifier is O.K.	See "GENERAL CHART"	
	B. Divergence in adjustment of stereo indicator circuit: <ol style="list-style-type: none"> <li>a. Aging or weak transistor in stereo indicator circuit</li> <li>b. Divergence in adjustment of circuit for protecting against malfunction of input</li> </ol>	T <sub>501</sub> , VR <sub>501</sub> ~VR <sub>502</sub> TR <sub>503</sub> ~TR <sub>505</sub> VR <sub>501</sub> , VR <sub>502</sub>	
Tuning meter does not work normally	A. Defective FM tuner	Check as above	
	B. Defective tuning indicator circuit	D <sub>201</sub> , D <sub>202</sub> , C <sub>018</sub> , R <sub>228</sub>	
	C. Loose contact of function selector switch	S <sub>1a</sub>	



## FOR USE WITH A RECORD PLAYER (MAGNETIC) OR A TAPE DECK

SYMPTOM	PROBABLE CAUSE		CHECK POINT
No sound	A. Program source defective		Check and repair or replace
	B. Defective overall section		See "No sound over all program sources"
	C. Defective equalizer amplifier	<ol style="list-style-type: none"> <li>1. Divergence of voltage specified in "SCHEMATIC DIAGRAM OF CIRCUITS"</li> <li>2. Insufficient capacity or capacitor</li> <li>3. Loose contact of rotary switch</li> <li>4. Loose contact of input terminal or pin plug</li> <li>5. Defective resistor</li> </ol>	Measure voltage in equalizer amplifier section and replace defective element  $C_{601}, C_{602}, C_{604} \sim C_{606}, C_{611}, C_{612}, C_{614}$ $S_{1c} \sim S_{1h}$  $R_{602} \sim R_{607}, R_{615} \sim R_{621}$
Weak sound	A. Program source defective		Check and repair or replace
	B. Defective overall section		See "Weak sound over all program sources"
	C. Defective equalizer amplifier	<ol style="list-style-type: none"> <li>1. Divergence of voltage specified in "SCHEMATIC DIAGRAM OF CIRCUITS"</li> <li>2. Divergence of capacity of capacitor</li> <li>3. Loose contact of rotary switch</li> <li>4. Loose contact of input terminal or pin plug</li> </ol>	Measure voltage in equalizer amplifier section and replace defective element  $C_{601}, C_{603}, C_{605}, C_{611}, C_{613}, C_{615}, C_{616}$ $S_{1c} \sim S_{1h}$ Check and repair
Distortion	A. Program source defective		Check and repair or replace
	B. Defective overall section		See "Distortion over all program sources"
	C. Defective equalizer amplifier	<ol style="list-style-type: none"> <li>1. Divergence of voltage specified in "SCHEMATIC DIAGRAM OF CIRCUITS"</li> <li>2. Capacitor, shorted or blown</li> <li>3. Defective resistor</li> <li>4. Weak or aging transistor</li> </ol>	Measure voltage in equalizer amplifier and replace defective element  $C_{601}, C_{603}, C_{605}, C_{606}, C_{611}, C_{613}, C_{615}, C_{616}$ $R_{602} \sim R_{612}, R_{615} \sim R_{625}$ $TR_{601} \sim TR_{604}$
Hum	A. Program source defective		Check and repair or replace
	B. Amplifier is O.K.	Improper connections	See "GENERAL CHART"
	C. Defective overall section		See "Hum over all program sources"
	D. Defective equalizer amplifier	Insufficient capacity of capacitor	$C_{604}$
Noise	A. Program source defective		Check and repair or replace
	B. Amplifier is O.K.		See "GENERAL CHART"

# TROUBLESHOOTING CHART

## FOR USE WITH A RECORD PLAYER (MAGNETIC) OR A TAPE DECK

SYMPTOM	PROBABLE CAUSE	CHECK POINT
Noisy	C. Defective overall section	See "Noise over all program sources"
	D. Defective equalizer amplifier	1. Divergence of voltage specified in "SCHEMATIC DIAGRAM OF CIRCUITS" 2. Capacitor, shorted or blown 3. Defective resistor 4. Weak or aging transistor
		Measure voltage in equalizer amplifier and replace defective element  $C_{601} \sim C_{606}$ , $C_{611} \sim C_{616}$ $R_{601} \sim R_{612}$ , $R_{614} \sim R_{625}$ $TR_{601}$ , $TR_{602}$

## OTHER PROGRAM SOURCES

SYMPTOM	PROBABLE CAUSE	CHECK POINT
When you will listen to TV or other sound outputs, the unit does not work normally	1. Defective program source 2. Improper or incorrect connections 3. Defective overall section	Check the program source Check for improper or incorrect connections See "OVER ALL PROGRAM SOURCES"
The unit does not work normally for use with a pin-plug tape recorder	1. Defective program source 2. Improper or incorrect connections 3. Defective overall section	Check the program source. Check for improper or incorrect connections See "OVER ALL PROGRAM SOURCES"
The unit does not work normally for use with a single connector (German standard) tape recorder	1. Defective program source 2. Improper or incorrect connections 3. Defective overall section 4. Defective input circuit	Check the program source Check for improper or incorrect connections See "OVER ALL PROGRAM SOURCES" DIN connector $R_{015} \sim R_{021}$

## RECORDING ON TAPE

SYMPTOM	PROBABLE CAUSE	CHECK POINT
Broadcast is not recorded well	1. Defective tape or tape recorder 2. Improper or incorrect connections 3. AM, FM or FM-STEREO program source defective	Check and repair or replace
Poor recording from record or tape	1. Defective tape or tape recorder 2. Improper or incorrect connections 3. RECORD PLAYER, TAPE HEAD or AUX input defective 4. Defective equalizer amplifier	Check and repair or replace  Check and repair See "FOR USE WITH A RECORD PLAYER OR A TAPE DECK: Defective head amplifier"

# GENERAL DISASSEMBLY PROCEDURE

## REMOVING THE FRONT PANEL, BONNET AND BOTTOM PLATE

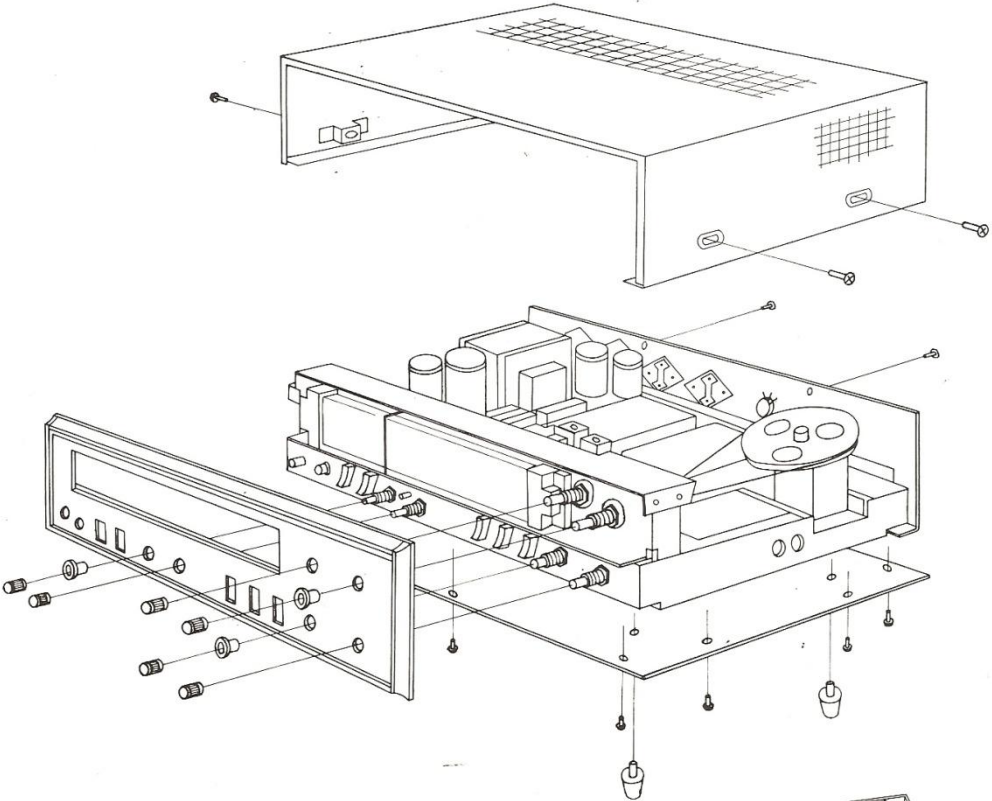

## DIAL MECHANISM

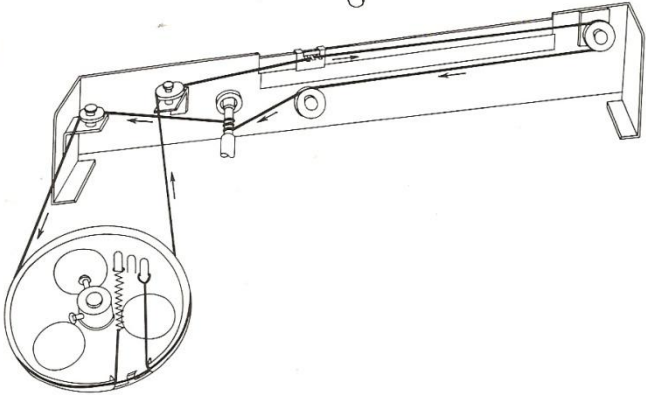



# PARTS LAYOUT

## TOP VIEW OF UPPER CHASSIS

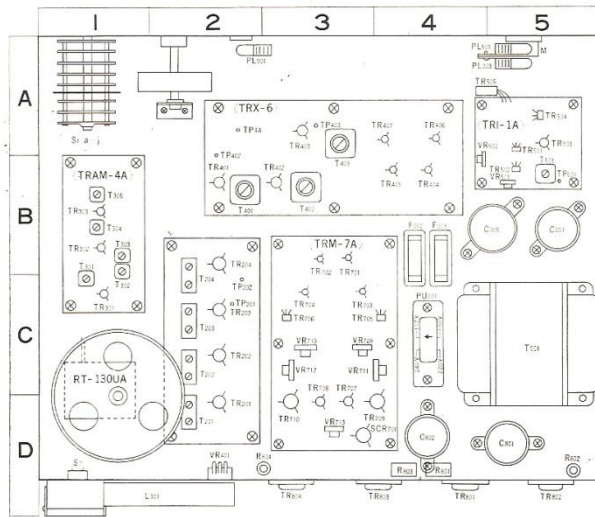

## SIDE VIEW OF BACK PANEL

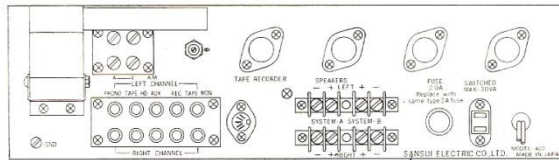

## TOP VIEW OF LOWER CHASSIS

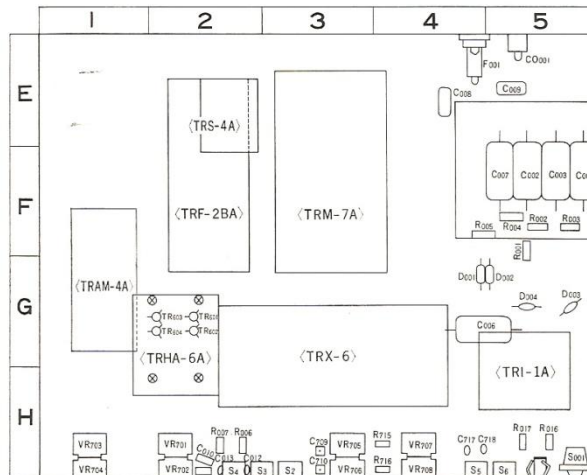

# BLOCK DIAGRAM OF PRINTED CIRCUIT

(See "PRINTED CIRCUIT SHEETS"—P. 22)

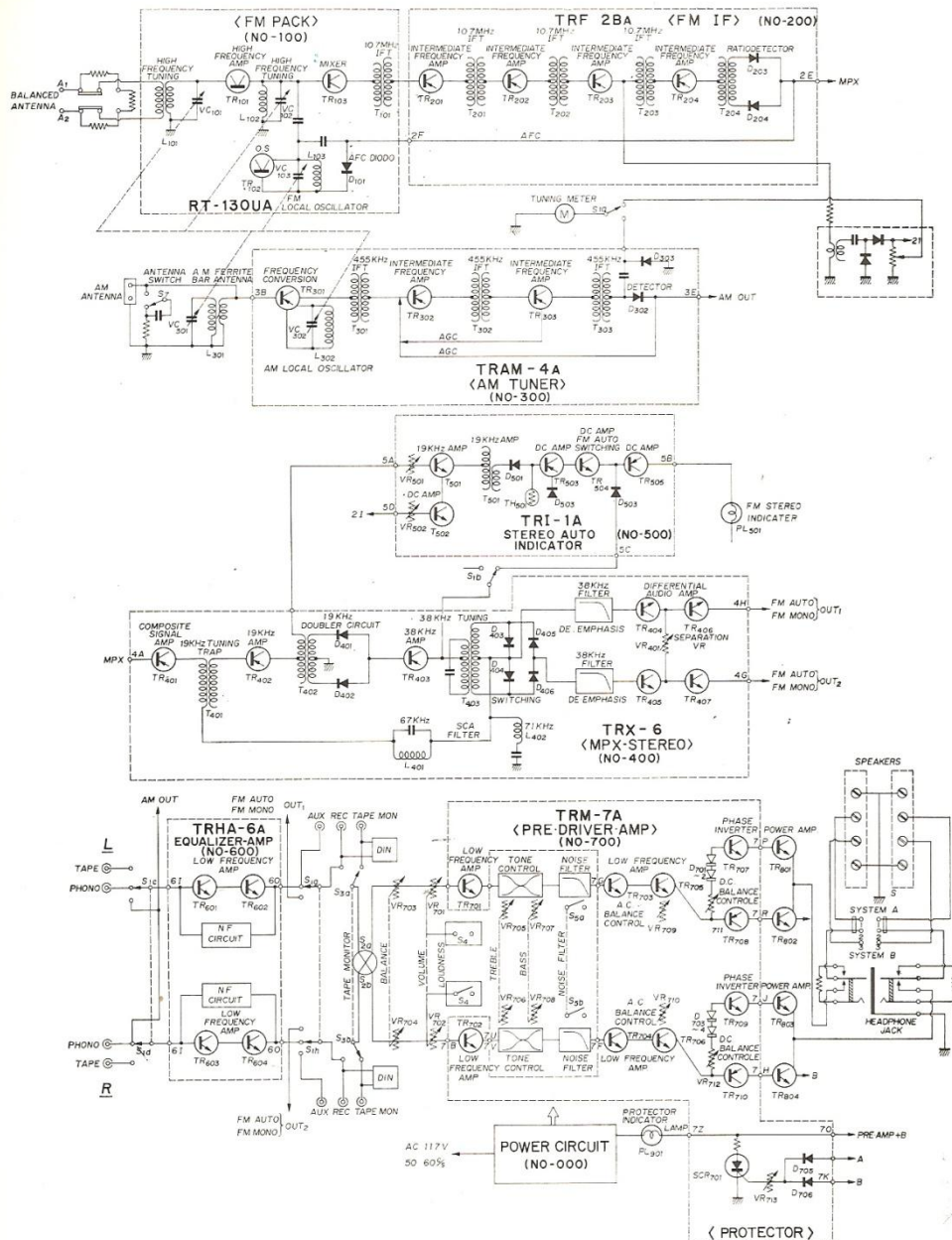

# SCHEMATIC DIAGRAM OF CIRCUITS

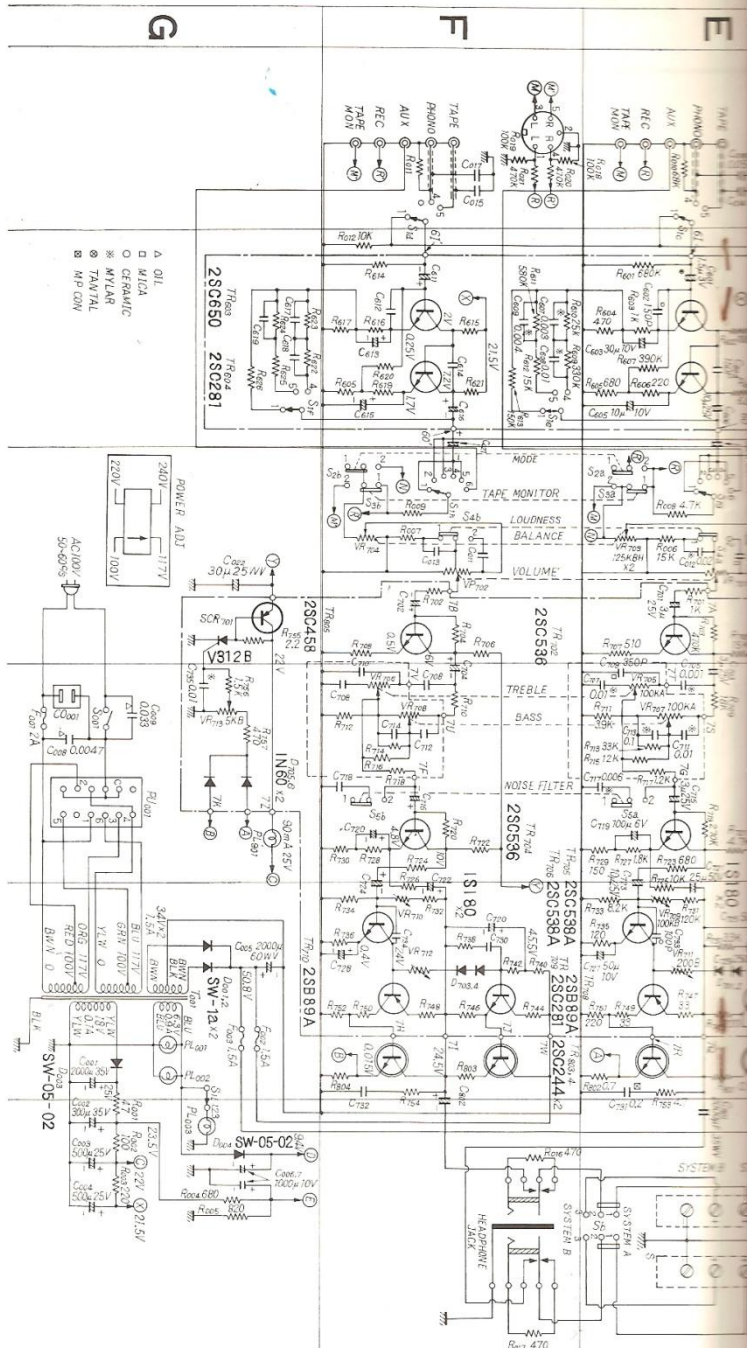



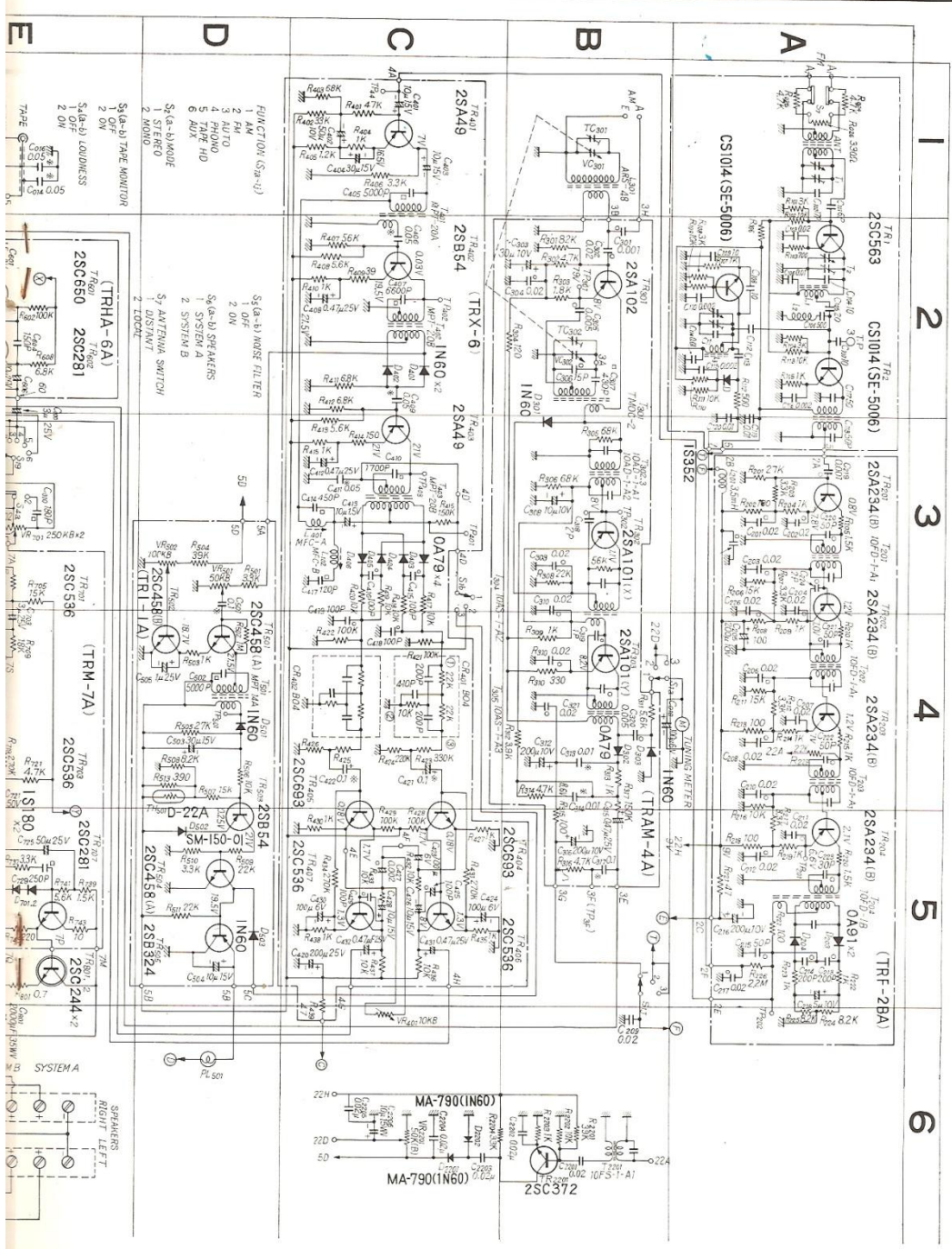

**A**

**B**

**C**

**D**

**E**

**F**

FUNCTION (S<sub>1</sub>-4)  
 1. AM  
 2. AUTO  
 4. PHONO  
 5. TAPE HD  
 6. AUX  
 S<sub>1</sub>(a-b)-MODE  
 1. STEREO  
 2. MONO

S<sub>2</sub>(a-b)-TONE MONITOR  
 1. OFF  
 2. ON

S<sub>3</sub>(a-b)-MODE SWITCH  
 1. SYSTEM A  
 2. SYSTEM B

S<sub>4</sub>(a-b)-TONE MONITOR  
 1. OFF  
 2. ON

S<sub>5</sub>(a-b)-TONE MONITOR  
 1. OFF  
 2. ON

S<sub>6</sub>(a-b)-TONE MONITOR  
 1. OFF  
 2. ON

S<sub>7</sub>(a-b)-TONE MONITOR  
 1. OFF  
 2. ON

S<sub>8</sub>(a-b)-TONE MONITOR  
 1. OFF  
 2. ON

# SELECTOR SWITCH CHART

Remove the bonnet and look at the switch from the back side of the amplifier. This chart tells you the location of their contact and supporting points. The smaller the circle, the nearer the points are located to the back of the amplifier.

- indicates a contact point of the selector switch.
- indicates a supporting point of the selector switch.

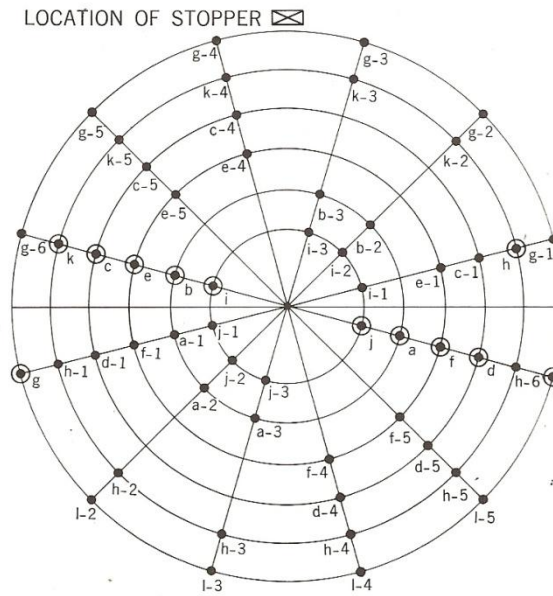

## SELECTOR SWITCH

$S_1 (a \sim j)$

POSITION OF SWITCHES  
(Co-ordinate numbers and letters in the circuit diagram)

$S_{1a} \dots 4 B$	$S_{1f} \dots 2 G$
$S_{1b} \dots 2 C$	$S_{1g} \dots 3 E$
$S_{1c} \dots 1 E$	$S_{1h} \dots 3 F$
$S_{1d} \dots 1 F$	$S_{1i} \dots 6 G$
$S_{1e} \dots 2 F$	$S_{1j} \dots 6 F$



# ALIGNMENT

## TEST POINTS

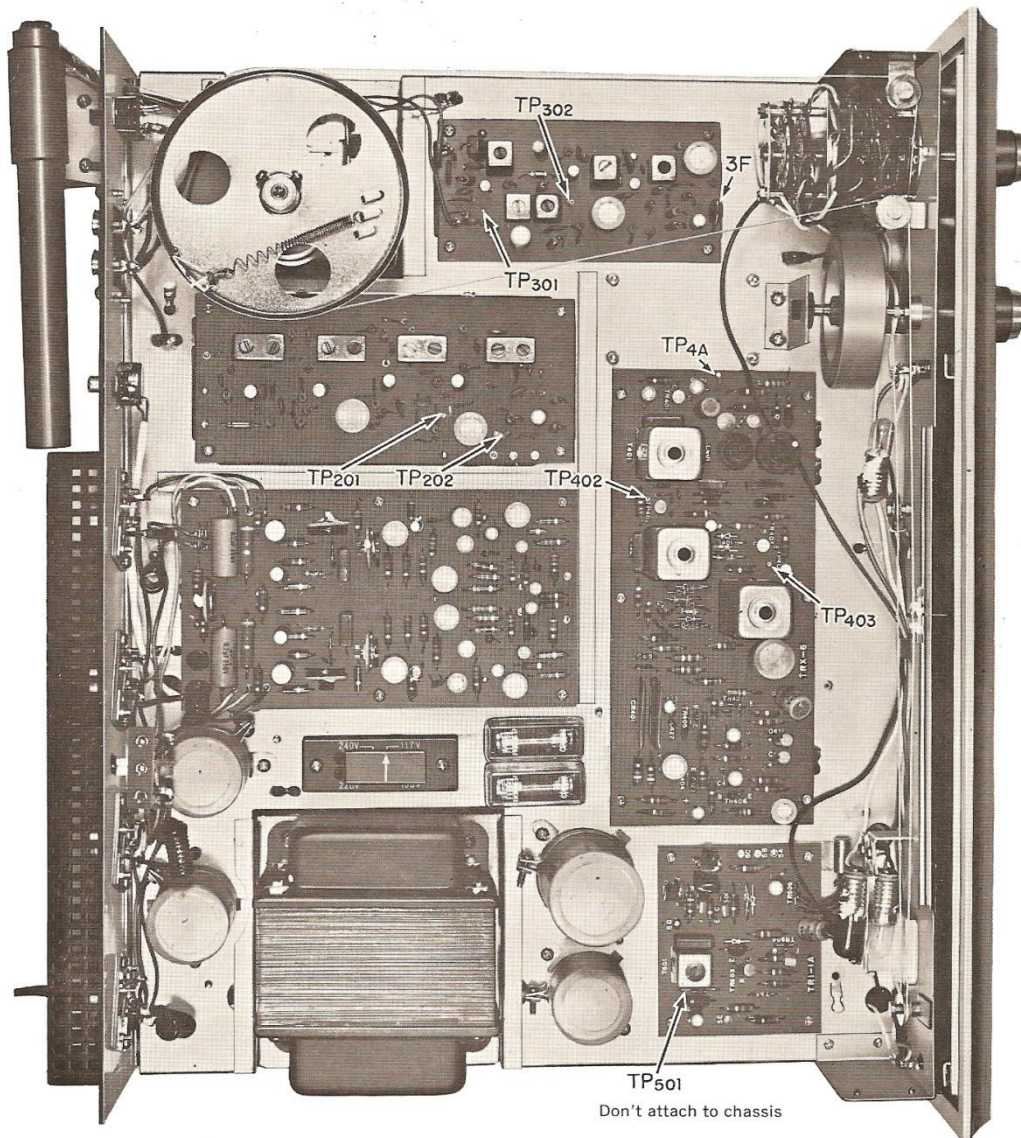



# ALIGNMENT

## ALIGNMENT PROCEDURE FOR FM TUNER

Note: To align, set the FM Signal Generator level to minimum

STEP	ALIGN	SIGNAL GENERATOR	FEED SIGNAL	DETECTOR OUTPUT	DIAL SETTING	ADJUST	ADJUST FOR
1.	IF transformer	10.7MHz $\pm 200$ KHz sweep generator	Antenna terminal	Connect oscilloscope to Test Point TP <sub>201</sub> through 0.02 $\mu$ F ceramic capacitor		Primary and secondary of IF transformer (T <sub>101</sub> , T <sub>201</sub> , T <sub>202</sub> , T <sub>203</sub> )	Best wave form
2.	Discriminator	10.7MHz $\pm 200$ KHz sweep generator	Antenna terminal	Connect oscilloscope to TP <sub>202</sub> through CR circuit as shown right		Primary and secondary of discriminator transformer (T <sub>204</sub> )	S curve 
3.	Local oscillator	FM signal generator 88MHz, 400Hz, 100% modulation	Antenna terminal	Connect oscilloscope and V.T.V.M. to load terminal (8 ohms)	88MHz	Local oscillator coil (L <sub>103</sub> )	Maximum wave form
4.	Local oscillator	FM signal generator 108MHz, 400Hz, 100% modulation	Antenna terminal	Connect oscilloscope and V.T.V.M. to load terminal (8 ohms)	108MHz	Local oscillator trimmer capacitor (TC <sub>103</sub> )	Maximum wave form
5.	Same as steps 3 and 4						
6.	High-frequency amp. circuit	FM signal generator 88MHz, 400Hz, 100% modulation	Antenna terminal	Connect oscilloscope and V.T.V.M. to load terminal (8 ohms)	88MHz	Antenna coil (L <sub>102</sub> and L <sub>104</sub> )	Maximum wave form
7.	High-frequency amp. circuit	FM signal generator 108MHz, 400Hz, 100% modulation	Antenna terminal	Connect oscilloscope and V.T.V.M. to load terminal (8 ohms)	108MHz	Trimmer capacitor (TC <sub>101</sub> and TC <sub>102</sub> )	Maximum wave form
8.	Same as steps 6 and 7						
9.	Antenna	FM signal generator 98MHz, 400Hz, 100% modulation	Antenna terminal	Connect oscilloscope and V.T.V.M. to load terminal (8 ohms)	98MHz	Antenna coil (L <sub>101</sub> )	Maximum wave form

FM IF CHARACTERISTIC

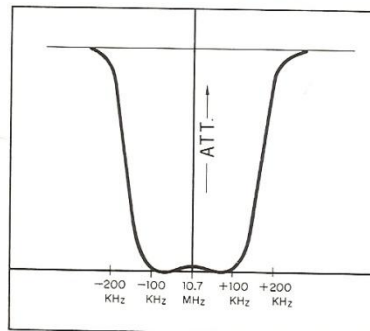

FM DISCRIMINATOR CHARACTERISTIC

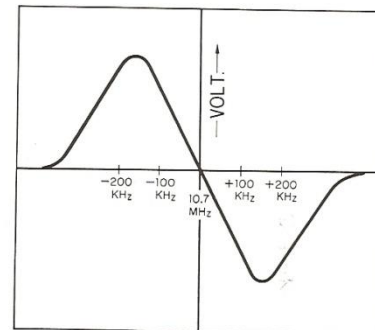

## ALIGNMENT PROCEDURE FOR FM MPX AND INDICATOR

1. Do not attempt to align the Multiplex Circuit unless the following equipment is available:

a. Multiplex Stereo Generator b. Oscilloscope c. V.T.V.M. d. Audio Generator e. FM Signal Generator

STEP	ALIGN	SIGNAL GENERATOR	FEED SIGNAL	DETECTOR OUTPUT	ADJUST	ADJUST FOR
1.	67KHz trap	Audio signal generator, 67KHz	TP <sub>4A</sub>	Connect V.T.V.M. to TP <sub>401</sub>	L <sub>401</sub> (MFC-A)	Minimum wave form
2.	71KHz trap	Audio signal generator, 71KHz	TP <sub>4A</sub>	Connect V.T.V.M. to TP <sub>401</sub>	L <sub>402</sub> (MFC-B)	Minimum wave form
3.	19KHz tuning coil	1) FM signal generator, 98MHz, 60dB 2) Stereo signal generator, 100% modulation of composite signal (L or R) including pilot signal	Antenna terminal	Connect oscilloscope and V.T.V.M. to TP <sub>402</sub>	T <sub>401</sub> (MPT-20A)	Maximum wave form
4.	19KHz tuning coil	1) FM signal generator, 98MHz, 60dB 2) Stereo signal generator, 100% modulation of composite signal (L or R) including pilot signal	Antenna terminal	Connect oscilloscope and V.T.V.M. to: 1) TP <sub>402</sub> or 2) Lead on coil side of D <sub>401</sub> and D <sub>402</sub>	T <sub>402</sub> (MPT-20B)	1) Maximum point of upper and lower cores connected 2) Maximum wave form
5.	19KHz tuning coil	1) FM signal generator, 98MHz, 60dB 2) Stereo signal generator, 100% modulation of composite signal (L or R) including pilot signal	Antenna terminal	Connect V.T.V.M. to TP <sub>501</sub>	T <sub>501</sub> (MPT-14A)	1) Maximum wave form 2) In this case, VR <sub>501</sub> and VR <sub>502</sub> should be at central point of the operation of the indicator
6.	38KHz tuning coil	1) FM signal generator, 98MHz, 60dB 2) Stereo signal generator, 100% modulation of composite signal (L or R) including pilot signal	Antenna terminal	Connect oscilloscope and V.T.V.M. to: 1) TP <sub>403</sub> or 2) Lead on coil side of D <sub>403</sub> ~D <sub>406</sub>	T <sub>403</sub> (MPT-20B)	1) Maximum point of upper and lower cores connected 2) Maximum wave form
7.	38KHz tuning coil Separation VR	1) FM signal generator, 98MHz, 60dB 2) Stereo signal generator, 100% modulation of composite signal (L or R) including pilot signal	Antenna terminal	Connect oscilloscope and V.T.V.M. to load terminal	T <sub>403</sub> (MPT-20B) VR <sub>401</sub>	1) Observe the wave form of the L channel output and adjust it to maximum within $\frac{1}{4}$ turn of T <sub>403</sub> 2) Adjust the separation VR (VR <sub>401</sub> ) for optimum separation

# ALIGNMENT

## ALIGNMENT FOR AM TUNER

Note: To align, set the AM Signal Generator level to minimum

STEP	ALIGN	SIGNAL GENERATOR	FEED SIGNAL	DETECTOR OUTPUT	DIAL SETTING	ADJUST	ADJUST FOR
1.	IF transformer	Sweep generator, 455KHz $\pm$ 30KHz	Antenna terminal	Connect oscilloscope to TP <sub>3F</sub>	Set to the position in which the generator is not affected during the broadcast	Primary and secondary of IF transformer (T <sub>302</sub> ~T <sub>305</sub> )	Best wave form
2.	Local oscillator	AM signal generator, 535KHz, 400Hz, 30% modulation	Antenna terminal	Connect oscilloscope and V.T.V.M. to load terminal	535KHz	Local oscillator coil (T <sub>301</sub> )	Maximum wave form
3.	Local oscillator	AM signal generator, 1605KHz, 400Hz, 30% modulation	Antenna terminal	Connect oscilloscope and V.T.V.M. to load terminal	1605KHz	Local oscillator trimmer capacitor (TC <sub>302</sub> )	Maximum wave form
4.	Same as steps 2 and 3						
5.	High-frequency amp	AM signal generator, 600KHz, 400Hz, 30% modulation	Antenna terminal	Connect oscilloscope and V.T.V.M. to load terminal	600KHz	Ferrite bar antenna coil (L <sub>301</sub> )	Maximum wave form
6.	High-frequency amp	AM signal generator, 1400KHz, 400Hz, 30% modulation	Antenna terminal	Connect oscilloscope and V.T.V.M. to load terminal	1400KHz	Trimmer capacitor (TC <sub>301</sub> )	Maximum wave form
7.	Same as steps 5 and 6 Check 1,000 KHz as well and adjust so that there is not a remarkable difference in sensitivity between them						

AM IF CHARACTERISTIC

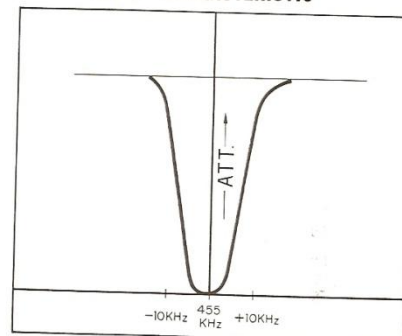



# PRINTED-CIRCUIT SHEETS

(See "BLOCK DIAGRAM OF PRINTED CIRCUITS" P. 14)

## HEAD AMPLIFIER (TRHA-6A)

### POSITION OF PARTS

R601...4 A	R614...1 A	C601...3 A	C615...1 A
R602...3 A	R615...2 A	C602...4 A	C616...2 B
R603...4 A	R616...1 A	C603...4 A	C617...1 C
R604...4 B	R617...1 B	C604...3 A	C618...1 B
R605...4 B	R618...1 B	C405...4 A	C619...2 B
R606...4 B	R619...1 B	C606...3 B	
R607...4 B	R620...1 B	C607...4 C	TR601...3 A
R608...3 B	R621...2 B	C608...4 B	TR602...3 A
R609...4 B	R622...1 B	C609...3 B	TR603...2 A
R610...4 C	R623...1 C	C611...2 A	TR604...2 A
R611...3 B	R624...2 B	C612...1 A	
R612...3 C	R625...2 C	C613...1 A	
R613...4 B	R626...2 B	C614...2 A	

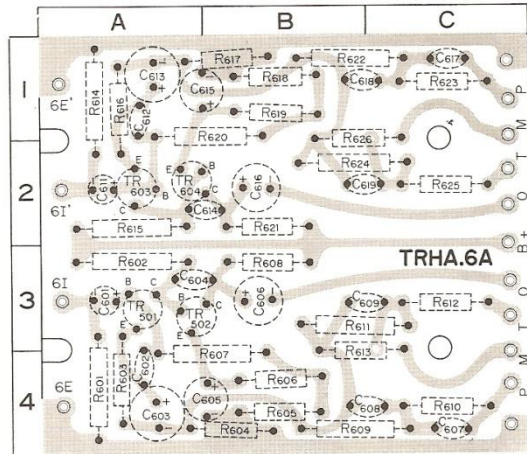

## CONTROL AMPLIFIER (TRM-7A)

### POSITION OF PARTS

R701...3 A	R722...2 B	R735...4 B	R750...1 D	C705...3 A	C728...1 B	VR713...3 D	D702...3 D
R702...2 A	R723...4 B	R736...1 B	R751...4 E	C706...2 A	C729...3 C		D703...2 D
R703...3 A	R724...2 B	R737...4 C	R752...1 E	C715...4 B	C730...2 C	TR701...3 A	D704...2 D
R704...2 A	R725...3 B	R738...1 C	R753...3 E	C716...1 B	C731...4 E	TR702...2 A	D705...1 E
R705...3 A	R726...2 B	R739...3 C	R754...2 E	C719...4 A	C732...1 E	TR703...3 B	D706...1 E
R706...2 A	R727...4 A	R740...2 C	R755...3 E	C720...1 A	C733...4 B	TR704...2 B	
R707...4 A	R728...1 A	R743...3 D	R756...3 D	C721...3 B	C734...1 B	TR705...4 C	SCR701...4 E
R708...1 A	R729...4 A	R744...2 D	R757...2 E	C722...2 B	C735...4 E	TR706...1 C	
R709...3 A	R730...1 A	R745...3 D		C723...3 B		TR707...3 D	
R710...2 A	R731...3 B	R746...2 D	C701...3 A	C724...2 B	VR709...3 C	TR708...2 D	
R711...3 B	R732...2 B	R747...4 D	C702...2 A	C725...4 C	VR710...2 C	TR709...4 D	
R720...2 B	R733...4 C	R748...1 D	C703...4 A	C726...1 C	VR711...4 D	TR710...1 D	
R721...3 B	R734...1 C	R749...4 D	C704...2 A	C727...4 B	VR712...1 D	D701...3 D	

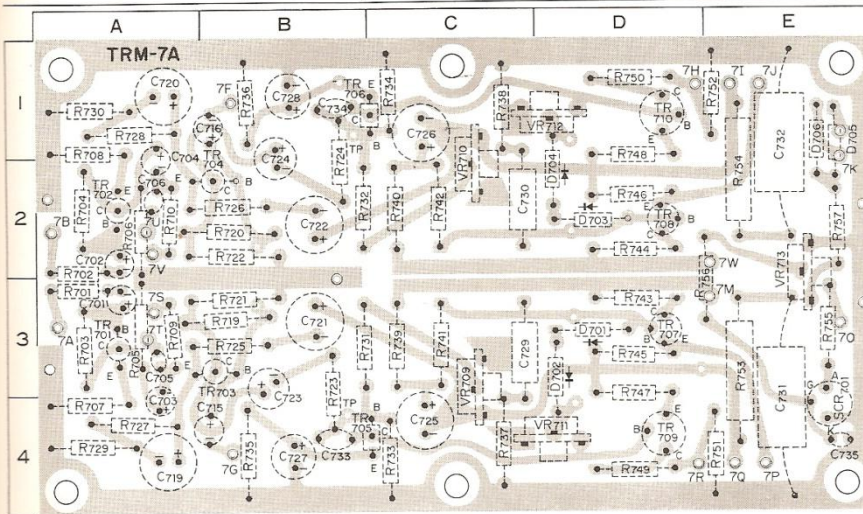

# PRINTED-CIRCUIT SHEETS

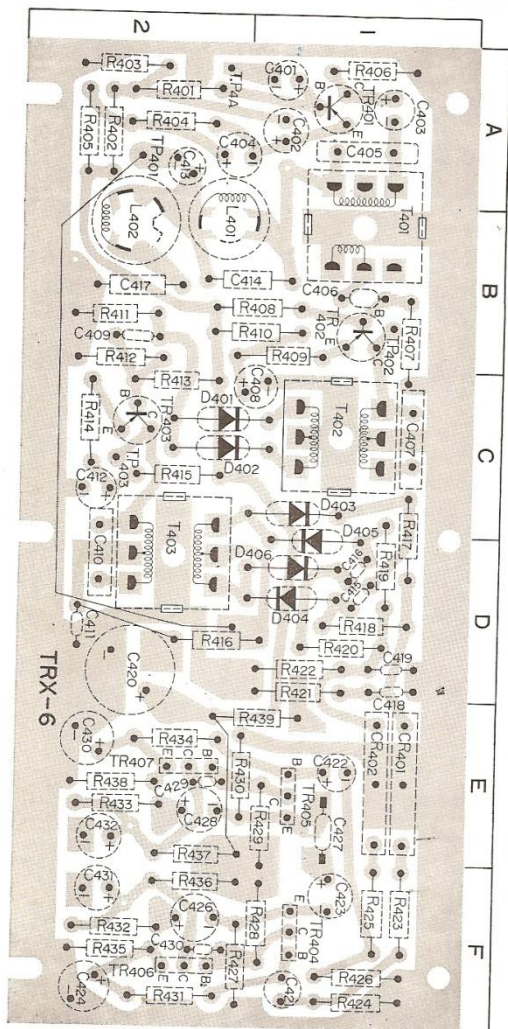

## FM MULTIPLEX (TRX-6)

### POSITION OF PARTS

R401 ... 2 A	R425 ... 1 F	C409 ... 2 B	CR401 ... 1 E
R402 ... 2 A	R426 ... 1 F	C410 ... 2 D	CR402 ... 1 E
R403 ... 2 A	R427 ... 1+2 F	C411 ... 2 D	
R404 ... 2 A	R428 ... 1 F	C412 ... 2 C	TR401 ... 1 A
R405 ... 2 A	R429 ... 1 E	C413 ... 2 A	TR402 ... 1 B
R406 ... 1 A	R430 ... 1+2 E	C414 ... 1 B	TR403 ... 2 C
R407 ... 1 B	R431 ... 2 F	C415 ... 1 D	TR404 ... 1 F
R408 ... 1 B	R432 ... 2 F	C416 ... 1 D	TR405 ... 1 E
R409 ... 1 B	R433 ... 2 E	C417 ... 2 B	TR406 ... 2 F
R410 ... 1 B	R434 ... 2 E	C418 ... 1 D	TR407 ... 2 E
R411 ... 2 B	R435 ... 2 F	C419 ... 1 D	
R412 ... 2 B	R436 ... 2 F	C420 ... 2 D	D401 ... 2 C
R413 ... 2 C	R437 ... 2 E	C421 ... 1 F	D402 ... 2 C
R414 ... 2 C	R438 ... 2 E	C422 ... 1 E	D403 ... 1 C
R415 ... 2 C	R439 ... 1 E	C423 ... 1 E	D404 ... 1 D
R416 ... 2 D		C424 ... 2 F	D405 ... 1 D
R417 ... 1 C	C401 ... 1 A	C425 ... 1 F	D406 ... 1 D
R418 ... 1 D	C402 ... 1 A	C426 ... 2 F	
R419 ... 1 D	C403 ... 1 A	C427 ... 1 E	L401 ... 2 B
R420 ... 1 D	C404 ... 2 A	C428 ... 2 E	L402 ... 2 B
R421 ... 1 D	C405 ... 1 A	C429 ... 2 E	
R422 ... 1 D	C406 ... 1 B	C430 ... 2 E	T401 ... 1 B
R423 ... 1 F	C407 ... 1 C	C431 ... 2 F	T402 ... 1 C
R424 ... 1 F	C408 ... 1 C	C432 ... 2 E	T403 ... 2 D

## STEREO INDICATOR (TRI-1A)

### POSITION OF PARTS

R501 ... 2 A	R509 ... 2 C	C505 ... 1 A	TR504 ... 2 B
R502 ... 1 A	R510 ... 2 C	VR501 ... 1 A	TR505 ... 2 A
R503 ... 1 A	R511 ... 2 B	VR502 ... 1 A	
R504 ... 1 A			D501 ... 1 C
R505 ... 1 C	C501 ... 1 A	T501 ... 1 B	D502 ... 1 B
R506 ... 1 C	C502 ... 1 B	TR501 ... 1 A	D503 ... 2 A
R507 ... 2 C	C503 ... 1 C	TR502 ... 1 A	
R508 ... 2 C	C504 ... 2 A	TR503 ... 2 B	Th501 ... 2 C

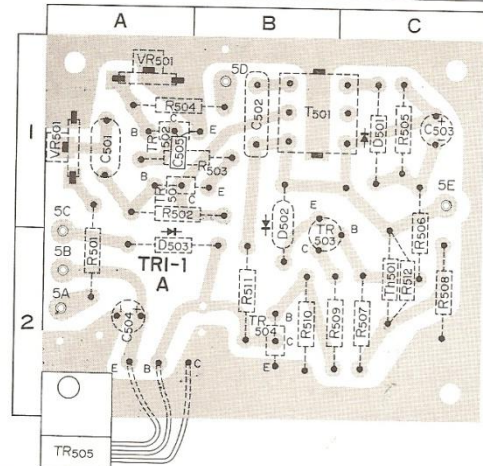



## AM IF (TRAM-4)

### POSITION OF PARTS

R301...2 A	R317...1 D	C315...1 D
R302...1 A		C316...2 D
R303...1 A	C301...1 A	C317...1 D
R304...1 B	C302...1 A	C318...2 B
R305...2 A	C303...1 B	C319...2 C
R306...1 B	C304...2 A	C320...2 D
R307...2 C	C305...2 A	C321...1 B
R308...2 B	C306...2 A	
R309...1 B	C307...2 A	T301...2 A
R310...1 C	C308...2 B	T302...1 B
R311...2 C	C309...2 B	T303...1 B
R312...1 D	C310...2 C	T304...2 C
R313...1 C	C311...1 C	T305...2 D
R314...1 C	C312...1 C	TR301...2 A
R315...1 D	C313...1 D	TR302...2 B
R316...2 D	C314...1 D	TR303...2 C

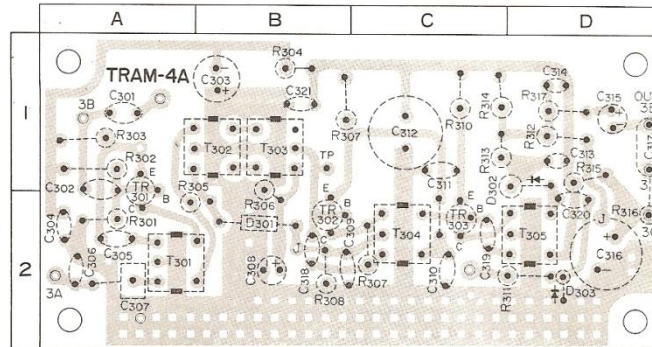

## FM IF AMPLIFICATION (TRF-2BA)

### POSITION OF PARTS

R201...2 A	R210...2 B	R219...1 D	R228...2 C	C208...1 C	C217...1 E	C226...1 B	TR201...1 A
R202...1 A	R211...2 C	R220...2 D		C209...2 C	C218...1 E		TR202...1 B
R203...1 A	R212...1 C	R221...1 D	C201...1 B	C210...2 D	C219...2 A	T201...2 A	TR203...1 C
R204...1 A	R213...1 C	R222...1 E	C202...1 B	C211...1 D	C220...2 A	T202...2 B	TR204...1 D
R205...2 A	R214...1 C	R223...1 E	C203...2 B	C212...1 D	C221...2 B	T203...2 C	
R206...2 B	R215...2 C	R224...1 E	C204...1 B	C213...1 E	C222...2 C	T204...2 E	D201...2 C
R207...1 B	R216...2 D	R225...1 E	C205...1 C	C214...1 E	C223...2 D		D202...2 C
R208...1 B	R217...1 D	R226...1 E	C206...2 C	C215...1 E	C224...2 B	L201...1 A	D203...2 E
R209...1 B	R218...1 D	R227...1 D	C207...1 C	C216...1 D	C225...1 C		D204...2 E

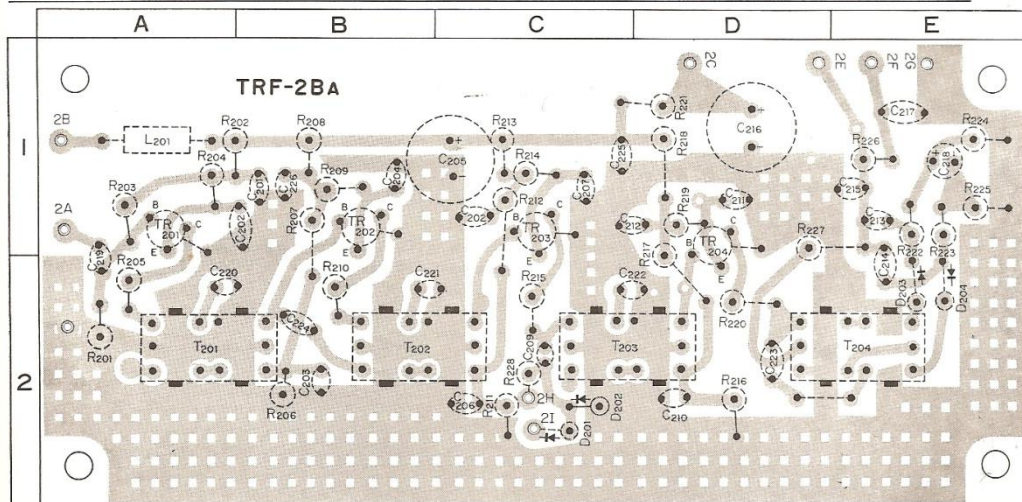



# PARTS LIST

A: Parts No.  
 B: Parts Name  
 C: Position of Parts (Co-ordinates in "SCHEMATIC DIAGRAM OF CIRCUITS")  
 D: Position of Parts (Co-ordinates in "PARTS LAYOUT" or by name of printed circuit)

A	B	C	D
R001	47Ω 1/2W ±10% Solid Fixed Resistor	6G	5G
R002	100Ω 1/2W ±10% Solid Fixed Resistor	6G	5F
R003	220Ω 1/2W ±10% Solid Fixed Resistor	6G	5F
R004	680Ω 1W ±10% RT Carbon Fixed Resistor	6G	5F
R005	820Ω 1/2W ±10% Solid Fixed Resistor	6G	5G
R006	15KΩ 1/2W ±10% Solid Fixed Resistor	3E	2H
R007	15KΩ 1/2W ±10% Solid Fixed Resistor	3F	2H
R008	4.7KΩ 1/2W ±10% Solid Fixed Resistor	3F	1A
R009	4.7KΩ 1/2W ±10% Solid Fixed Resistor	3F	1A
R010	68KΩ 1/4W ±10% R Carbon Fixed Resistor (noiseless)	1E	1E
R011	68KΩ 1/4W ±10% R Carbon Fixed Resistor (noiseless)	1F	1E
R012	820Ω 1/2W ±10% Solid Fixed Resistor	2F	1A
R016	470Ω 1/2W ±10% Solid Fixed Resistor	6E	5H
R017	470Ω 1/2W ±10% Solid Fixed Resistor	6E	5H
R018	100KΩ 1/2W ±10% Solid Fixed Resistor	1F	2E
R019	100KΩ 1/2W ±10% Solid Fixed Resistor	1F	2E
R020	470KΩ 1/2W ±10% Solid Fixed Resistor	1F	2E
R021	470KΩ 1/2W ±10% Solid Fixed Resistor	1F	2E
R023	1KΩ 1/2W ±10% Solid Fixed Resistor	5B	
R024	4.7KΩ 1/2W ±10% Solid Fixed Resistor	5B	
R025	4.7KΩ 1/2W ±10% Solid Fixed Resistor	5B	
R026	330Ω 1/2W ±10% Solid Fixed Resistor	5B	
R101	3KΩ 1/2W ±10% Carbon Fixed Resistor	1A	RT-130UA-6
R102	10KΩ 1/2W ±10% Carbon Fixed Resistor	1A	RT-130UA-6
R103	700Ω 1/2W ±10% Carbon Fixed Resistor	2A	RT-130UA-6
R104	3KΩ 1/2W ±10% Carbon Fixed Resistor	2A	RT-130UA-6
R105	1KΩ 1/2W ±10% Carbon Fixed Resistor	2A	RT-130UA-6
R106	1.5KΩ 1/2W ±10% Carbon Fixed Resistor	2A	RT-130UA-6
R107	1KΩ 1/2W ±10% Carbon Fixed Resistor	2A	RT-130UA-6
R108	3KΩ 1/2W ±10% Carbon Fixed Resistor	2A	RT-130UA-6
R109	10KΩ 1/2W ±10% Carbon Fixed Resistor	2A	RT-130UA-6
R110	15KΩ 1/2W ±10% Carbon Fixed Resistor	2A	RT-130UA-6
R111	10KΩ 1/2W ±10% Carbon Fixed Resistor	2A	RT-130UA-6
R112	500KΩ 1/2W ±10% Carbon Fixed Resistor	2A	RT-130UA-6
R113	10KΩ 1/2W ±10% Carbon Fixed Resistor	2A	RT-130UA-6
R201	27KΩ 1/2W ±10% Solid Fixed Resistor	3A	TRF-2BA
R202	100Ω 1/2W ±10% Solid Fixed Resistor	3A	TRF-2BA
R203	3.3KΩ 1/2W ±10% Solid Fixed Resistor	3A	TRF-2BA
R204	1KΩ 1/2W ±10% Solid Fixed Resistor	3A	TRF-2BA
R205	1.5KΩ 1/2W ±10% Solid Fixed Resistor	3A	TRF-2BA
R206	15KΩ 1/2W ±10% Solid Fixed Resistor	3A	TRF-2BA
R207	3.3KΩ 1/2W ±10% Solid Fixed Resistor	3A	TRF-2BA
R208	100Ω 1/2W ±10% Solid Fixed Resistor	4A	TRF-2BA
R209	1KΩ 1/2W ±10% Solid Fixed Resistor	4A	TRF-2BA
R210	1KΩ 1/2W ±10% Solid Fixed Resistor	4A	TRF-2BA
R211	15KΩ 1/2W ±10% Solid Fixed Resistor	4A	TRF-2BA
R212	3.3KΩ 1/2W ±10% Solid Fixed Resistor	4A	TRF-2BA
R213	100Ω 1/2W ±10% Solid Fixed Resistor	4A	TRF-2BA
R214	1KΩ 1/2W ±10% Solid Fixed Resistor	4A	TRF-2BA
R215	1KΩ 1/2W ±10% Solid Fixed Resistor	4A	TRF-2BA
R216	10KΩ 1/2W ±10% Solid Fixed Resistor	4A	TRF-2BA
R217	3.3KΩ 1/2W ±10% Solid Fixed Resistor	5A	TRF-2BA
R218	100Ω 1/2W ±10% Solid Fixed Resistor	5A	TRF-2BA
R219	1KΩ 1/2W ±10% Solid Fixed Resistor	5A	TRF-2BA
R220	1.5KΩ 1/2W ±10% Solid Fixed Resistor	5A	TRF-2BA
R221	47Ω 1/2W ±10% Solid Fixed Resistor	5A	TRF-2BA
R222	1KΩ 1/2W ±10% Solid Fixed Resistor	5A	TRF-2BA

A	B	C	D
R223	1KΩ 1/2W ±10% Solid Fixed Resistor	5A	TRF-2BA
R224	4.7KΩ 1/2W ±10% Solid Fixed Resistor	6A	TRF-2BA
R225	4.7KΩ 1/2W ±10% Solid Fixed Resistor	6A	TRF-2BA
R226	1.5MΩ 1/2W ±10% Solid Fixed Resistor	5A	TRF-2BA
R227	100Ω 1/2W ±10% Solid Fixed Resistor	5A	TRF-2BA
R228	33KΩ 1/2W ±10% Solid Fixed Resistor	4A	TRF-2BA
R229	22KΩ 1/2W ±10% Solid Fixed Resistor	6B	TRF-2BA
R2201	39KΩ 1/2W ±10% Solid Fixed Resistor	4A	TRS-4A
R2202	10KΩ 1/2W ±10% Solid Fixed Resistor	6B	TRS-4A
R2203	1KΩ 1/2W ±10% Solid Fixed Resistor	6B	TRS-4A
R2204	3.3KΩ 1/2W ±10% Solid Fixed Resistor	6B	TRS-4A
R301	82KΩ 1/2W ±10% Solid Fixed Resistor	2B	TRAM-4A-6
R302	4.7KΩ 1/2W ±10% Solid Fixed Resistor	2B	TRAM-4A-6
R303	1.8KΩ 1/2W ±10% Solid Fixed Resistor	2B	TRAM-4A-6
R304	120Ω 1/2W ±10% Solid Fixed Resistor	2B	TRAM-4A-6
R305	68KΩ 1/2W ±10% Solid Fixed Resistor	3B	TRAM-4A-6
R306	68KΩ 1/2W ±10% Solid Fixed Resistor	3B	TRAM-4A-6
R307	56KΩ 1/2W ±10% Solid Fixed Resistor	3B	TRAM-4A-6
R308	2.2KΩ 1/2W ±10% Solid Fixed Resistor	3B	TRAM-4A-6
R309	1KΩ 1/2W ±10% Solid Fixed Resistor	4B	TRAM-4A-6
R310	330Ω 1/2W ±10% Solid Fixed Resistor	4B	TRAM-4A-6
R311	3.3KΩ 1/2W ±10% Solid Fixed Resistor	4B	TRAM-4A-6
R312	3.9KΩ 1/2W ±10% Solid Fixed Resistor	4B	TRAM-4A-6
R313	1KΩ 1/2W ±10% Solid Fixed Resistor	4B	TRAM-4A-6
R314	4.7KΩ 1/2W ±10% Solid Fixed Resistor	4B	TRAM-4A-6
R315	100Ω 1/2W ±10% Solid Fixed Resistor	5B	TRAM-4A-6
R316	4.7KΩ 1/2W ±10% Solid Fixed Resistor	5B	TRAM-4A-6
R317	15KΩ 1/2W ±10% Solid Fixed Resistor	5B	TRAM-4A-6
R401	47KΩ 1/2W ±10% Solid Fixed Resistor	1C	TRX-6
R402	33KΩ 1/2W ±10% Solid Fixed Resistor	1C	TRX-6
R403	68KΩ 1/2W ±10% Solid Fixed Resistor	1C	TRX-6
R404	1KΩ 1/2W ±10% Solid Fixed Resistor	1C	TRX-6
R405	1.2KΩ 1/2W ±10% Solid Fixed Resistor	1C	TRX-6
R406	3.3KΩ 1/2W ±10% Solid Fixed Resistor	1C	TRX-6
R407	56KΩ 1/2W ±10% Solid Fixed Resistor	2C	TRX-6
R408	5.6KΩ 1/2W ±10% Solid Fixed Resistor	2C	TRX-6
R409	39Ω 1/2W ±10% Solid Fixed Resistor	2C	TRX-6
R410	1KΩ 1/2W ±10% Solid Fixed Resistor	2C	TRX-6
R411	6.8KΩ 1/2W ±10% Solid Fixed Resistor	2C	TRX-6
R412	68KΩ 1/2W ±10% Solid Fixed Resistor	3C	TRX-6
R413	5.6KΩ 1/2W ±10% Solid Fixed Resistor	3C	TRX-6
R414	150Ω 1/2W ±10% Solid Fixed Resistor	3C	TRX-6
R415	1KΩ 1/2W ±10% Solid Fixed Resistor	3C	TRX-6
R416	150KΩ 1/2W ±10% Solid Fixed Resistor	3C	TRX-6
R417	10KΩ 1/2W ±10% Solid Fixed Resistor	3C	TRX-6
R418	10KΩ 1/2W ±10% Solid Fixed Resistor	3C	TRX-6
R419	10KΩ 1/2W ±10% Solid Fixed Resistor	3C	TRX-6
R420	10KΩ 1/2W ±10% Solid Fixed Resistor	3C	TRX-6
R421	100KΩ 1/2W ±10% Solid Fixed Resistor	4C	TRX-6
R422	100KΩ 1/2W ±10% Solid Fixed Resistor	4C	TRX-6
R423	330KΩ 1/2W ±10% Solid Fixed Resistor	4C	TRX-6
R424	220KΩ 1/2W ±10% Solid Fixed Resistor	4C	TRX-6
R425	330KΩ 1/2W ±10% Solid Fixed Resistor	4C	TRX-6
R426	220KΩ 1/2W ±10% Solid Fixed Resistor	4C	TRX-6
R427	1KΩ 1/2W ±10% Solid Fixed Resistor	5C	TRX-6
R428	100KΩ 1/2W ±10% Solid Fixed Resistor	5C	TRX-6
R429	100KΩ 1/2W ±10% Solid Fixed Resistor	5C	TRX-6
R430	1KΩ 1/2W ±10% Solid Fixed Resistor	5C	TRX-6
R431	270KΩ 1/2W ±10% Solid Fixed Resistor	5C	TRX-6

A	B	C	D
R432	10KΩ 1/2W ±10% Solid Fixed Resistor	5C	TRX-6
R433	10KΩ 1/2W ±10% Solid Fixed Resistor	5C	TRX-6
R434	270KΩ 1/2W ±10% Solid Fixed Resistor	5C	TRX-6
R435	1KΩ 1/2W ±10% Solid Fixed Resistor	5C	TRX-6
R436	10KΩ 1/2W ±10% Solid Fixed Resistor	5C	TRX-6
R437	10KΩ 1/2W ±10% Solid Fixed Resistor	5C	TRX-6
R438	1KΩ 1/2W ±10% Solid Fixed Resistor	5C	TRX-6
R439	47Ω 1/2W ±10% Solid Fixed Resistor	6C	TRX-6
R501	3.3KΩ 1/2W ±10% Solid Fixed Resistor	3D	TRI-1A
R502	1MΩ 1/2W ±10% Solid Fixed Resistor	4D	TRI-1A
R503	1KΩ 1/2W ±10% Solid Fixed Resistor	4D	TRI-1A
R504	39KΩ 1/2W ±10% Solid Fixed Resistor	3D	TRI-1A
R505	27KΩ 1/2W ±10% Solid Fixed Resistor	4D	TRI-1A
R506	10KΩ 1/2W ±10% Solid Fixed Resistor	4D	TRI-1A
R507	15KΩ 1/2W ±10% Solid Fixed Resistor	4D	TRI-1A
R508	8.2KΩ 1/2W ±10% Solid Fixed Resistor	4D	TRI-1A
R509	22KΩ 1/2W ±10% Solid Fixed Resistor	5D	TRI-1A
R510	3.3KΩ 1/2W ±10% Solid Fixed Resistor	5D	TRI-1A
R511	22KΩ 1/2W ±10% Solid Fixed Resistor	5D	TRI-1A
R512	390Ω 1/2W ±10% Solid Fixed Resistor	5D	TRI-1A
R601	680KΩ 1/4W ±10% RD Carbon Fixed Resistor (noiseless)	2E	TRHA-6A
R602	100KΩ 1/4W ±10% RD Carbon Fixed Resistor (noiseless)	2E	TRHA-6A
R603	1KΩ 1/4W ±10% R Carbon Fixed Resistor (noiseless)	2E	TRHA-6A
R604	470Ω 1/4W ±10% R Carbon Fixed Resistor (noiseless)	2E	TRHA-6A
R605	680Ω 1/4W ±10% R Carbon Fixed Resistor (noiseless)	2E	TRHA-6A
R606	220Ω 1/4W ±10% R Carbon Fixed Resistor (noiseless)	2E	TRHA-6A
R607	390KΩ 1/4W ±10% RD Carbon Fixed Resistor (noiseless)	2E	TRHA-6A
R608	6.8KΩ 1/4W ±10% R Carbon Fixed Resistor	2E	TRHA-6A
R609	330KΩ 1/4W ±10% RD Carbon Fixed Resistor	2F	TRHA-6A
R610	25KΩ 1/4W ±10% R Carbon Fixed Resistor	2F	TRHA-6A
R611	680KΩ 1/4W ±10% R Carbon Fixed Resistor (noiseless)	2F	TRHA-6A
R612	15KΩ 1/4W ±10% R Carbon Fixed Resistor	2F	TRHA-6A
R613	150KΩ 1/4W ±10% R Carbon Fixed Resistor	2F	TRHA-6A
R614	680KΩ 1/4W ±10% RD Carbon Fixed Resistor (noiseless)	2F	TRHA-6A
R615	100KΩ 1/4W ±10% RD Carbon Fixed Resistor (noiseless)	2F	TRHA-6A
R616	1KΩ 1/4W ±10% R Carbon Fixed Resistor (noiseless)	2F	TRHA-6A
R617	470Ω 1/4W ±10% R Carbon Fixed Resistor (noiseless)	2F	TRHA-6A
R618	680Ω 1/4W ±10% R Carbon Fixed Resistor (noiseless)	2F	TRHA-6A
R619	220Ω 1/4W ±10% R Carbon Fixed Resistor (noiseless)	2F	TRHA-6A
R620	390KΩ 1/4W ±10% R Carbon Fixed Resistor (noiseless)	2F	TRHA-6A
R621	6.8KΩ 1/4W ±10% R Carbon Fixed Resistor	2F	TRHA-6A
R622	330KΩ 1/4W ±10% RD Carbon Fixed Resistor	2G	TRHA-6A
R623	25KΩ 1/4W ±10% R Carbon Fixed Resistor	2G	TRHA-6A
R624	680KΩ 1/4W ±10% RD Carbon Fixed Resistor (noiseless)	2G	TRHA-6A
R625	15KΩ 1/4W ±10% R Carbon Fixed Resistor	2G	TRHA-6A
R626	150KΩ 1/4W ±10% R Carbon Fixed Resistor	2G	TRHA-6A
R701	1KΩ 1/2W ±10% Solid Fixed Resistor	3E	TRM-7A
R702	1KΩ 1/2W ±10% Solid Fixed Resistor	3F	TRM-7A
R703	470KΩ 1/2W ±10% Solid Fixed Resistor	3E	TRM-7A
R704	470KΩ 1/2W ±10% Solid Fixed Resistor	3F	TRM-7A
R705	15KΩ 1/2W ±10% Solid Fixed Resistor	3E	TRM-7A
R706	15KΩ 1/2W ±10% Solid Fixed Resistor	3F	TRM-7A

A	B	C	D
R707	510Ω 1/2W ±10% Solid Fixed Resistor	3E	TRM-7A
R708	510Ω 1/2W ±10% Solid Fixed Resistor	3F	TRM-7A
R709	18KΩ 1/2W ±10% Solid Fixed Resistor	4E	TRM-7A
R710	18KΩ 1/2W ±10% Solid Fixed Resistor	4F	TRM-7A
R711	3.9KΩ 1/2W ±10% Solid Fixed Resistor	4E	4H
R712	3.9KΩ 1/2W ±10% Solid Fixed Resistor	4F	4H
R713	33KΩ 1/4W ±10% R Carbon Fixed Resistor	4E	4H
R714	33KΩ 1/4W ±10% R Carbon Fixed Resistor	4F	4H
R715	12KΩ 1/2W ±10% Solid Fixed Resistor	4E	4H
R716	12KΩ 1/2W ±10% Solid Fixed Resistor	4F	4H
R717	1.2KΩ 1/2W ±10% Solid Fixed Resistor	4E	3H
R718	1.2KΩ 1/2W ±10% Solid Fixed Resistor	4F	3H
R719	270KΩ 1/2W ±10% Solid Fixed Resistor	4E	TRM-7A
R720	270KΩ 1/2W ±10% Solid Fixed Resistor	4F	TRM-7A
R721	4.7KΩ 1/2W ±10% Solid Fixed Resistor	4E	TRM-7A
R722	4.7KΩ 1/2W ±10% Solid Fixed Resistor	4F	TRM-7A
R723	680Ω 1/2W ±10% Solid Fixed Resistor	4E	TRM-7A
R724	680Ω 1/2W ±10% Solid Fixed Resistor	4F	TRM-7A
R725	10KΩ 1/2W ±10% Solid Fixed Resistor	5E	TRM-7A
R726	10KΩ 1/2W ±10% Solid Fixed Resistor	5F	TRM-7A
R727	1.8KΩ 1/2W ±10% Solid Fixed Resistor	4E	TRM-7A
R728	1.8KΩ 1/2W ±10% Solid Fixed Resistor	4F	TRM-7A
R729	150Ω 1/2W ±10% Solid Fixed Resistor	4E	TRM-7A
R730	150Ω 1/2W ±10% Solid Fixed Resistor	4F	TRM-7A
R731	120KΩ 1/2W ±10% Solid Fixed Resistor	5E	TRM-7A
R732	120KΩ 1/2W ±10% Solid Fixed Resistor	5F	TRM-7A
R733	8.2KΩ 1/2W ±10% Solid Fixed Resistor	5E	TRM-7A
R734	8.2KΩ 1/2W ±10% Solid Fixed Resistor	5F	TRM-7A
R735	120Ω 1/2W ±10% Solid Fixed Resistor	5E	TRM-7A
R736	120Ω 1/2W ±10% Solid Fixed Resistor	5F	TRM-7A
R737	3.3KΩ 1/2W ±10% Solid Fixed Resistor	5E	TRM-7A
R738	3.3KΩ 1/2W ±10% Solid Fixed Resistor	5F	TRM-7A
R739	1.5KΩ 1/2W ±10% Solid Fixed Resistor	5E	TRM-7A
R740	1.5KΩ 1/2W ±10% Solid Fixed Resistor	5F	TRM-7A
R741	5.6KΩ 1/2W ±10% Solid Fixed Resistor	5E	TRM-7A
R742	5.6KΩ 1/2W ±10% Solid Fixed Resistor	5F	TRM-7A
R743	10Ω 1/2W ±10% Solid Fixed Resistor	5E	TRM-7A
R744	10Ω 1/2W ±10% Solid Fixed Resistor	5F	TRM-7A
R745	220Ω 1/2W ±10% Solid Fixed Resistor	5E	TRM-7A
R746	220Ω 1/2W ±10% Solid Fixed Resistor	5F	TRM-7A
R747	33Ω 1/2W ±10% Solid Fixed Resistor	5E	TRM-7A
R748	33Ω 1/2W ±10% Solid Fixed Resistor	5F	TRM-7A
R749	33Ω 1/2W ±10% Solid Fixed Resistor	5E	TRM-7A
R750	33Ω 1/2W ±10% Solid Fixed Resistor	5F	TRM-7A
R751	220Ω 1/2W ±10% Solid Fixed Resistor	5E	TRM-7A
R752	220Ω 1/2W ±10% Solid Fixed Resistor	5F	TRM-7A
R753	4.7Ω 1W ±10% RT Carbon Fixed Resistor	6E	TRM-7A
R754	4.7Ω 1W ±10% RT Carbon Fixed Resistor	6F	TRM-7A
R755	2.2Ω 1/2W ±10% Solid Fixed Resistor	3G	TRM-7A
R756	1.5KΩ 1/2W ±10% Solid Fixed Resistor	4G	TRM-7A
R757	470Ω 1/2W ±10% Solid Fixed Resistor	4G	TRM-7A
R801	0.7Ω 2W ±10% Wire Wound Resistor	5E	4D
R802	0.7Ω 2W ±10% Wire Wound Resistor	5E	5D
R803	0.7Ω 2W ±10% Wire Wound Resistor	5F	4D
R804	0.7Ω 2W ±10% Wire Wound Resistor	5F	3D
C001	2000μF 35WV Lug Electrolytic Capacitor	5G	5B
C002	300μF 35WV Tubular Electrolytic Capacitor	6G	5F



# PARTS LIST

A: Parts No.  
 B: Parts Name  
 C: Position of Parts (Co-ordinates in "SCHEMATIC DIAGRAM OF CIRCUITS")  
 D: Position of Parts (Co-ordinates in "PARTS LAYOUT" or by name of printed circuit)

A	B	C	D
C003	500 $\mu$ F 25WV Tubular Electrolytic Capacitor	6G	5F
C004	500 $\mu$ F 25WV Tubular Electrolytic Capacitor	6G	5F
C005	2000 $\mu$ F 60WV Lug Electrolytic Capacitor	5G	5B
C006	1000 $\mu$ F 10WV Tubular Electrolytic Capacitor	6G	4G
C007	1000 $\mu$ F 10WV Tubular Electrolytic Capacitor	6G	5F
C008	0.0047 $\mu$ F 600WV $\pm 10\%$ Oil Capacitor	4G	4E
C009	0.033 $\mu$ F 600WV $\pm 10\%$ Oil Capacitor	4G	5E
C010	180 pF 250WV $\pm 10\%$ Mica Capacitor	3E	2H
C011	180 pF 250WV $\pm 10\%$ Mica Capacitor	3F	2H
C012	0.02 $\mu$ F 50WV $\pm 10\%$ Mylar Capacitor	3E	2H
C013	0.02 $\mu$ F 50WV $\pm 10\%$ Mylar Capacitor	3F	2H
C014	0.05 $\mu$ F 50WV $\pm 10\%$ Mylar Capacitor	1E	2E
C015	0.05 $\mu$ F 50WV $\pm 10\%$ Mylar Capacitor	1F	2E
C016	0.05 $\mu$ F 50WV $\pm 10\%$ Mylar Capacitor	1E	1E
C017	0.05 $\mu$ F 50WV $\pm 10\%$ Mylar Capacitor	1F	1E
C018	100 $\mu$ F 6WV RB Electrolytic Capacitor	4B	1A
C020	3 $\mu$ F 25WV RB Electrolytic Capacitor	2E	1A
C021	3 $\mu$ F 25WV RB Electrolytic Capacitor	2F	1A
C022	30 $\mu$ F 25WV RB Electrolytic Capacitor	2F	1A
C101	6 pF 50WV Ceramic Capacitor	1A	RT-130UA-6
C102	17 pF 50WV Ceramic Capacitor	1A	RT-130UA-6
C103	0.002 $\mu$ F 50WV Ceramic Capacitor	2A	RT-130UA-6
C104	10 pF 50WV Ceramic Capacitor	2A	RT-130UA-6
C105	0.01 pF 50WV Ceramic Capacitor	2A	RT-130UA-6
C106	20 pF 50WV Ceramic Capacitor	2A	RT-130UA-6
C107	10 pF 50WV Ceramic Capacitor	2A	RT-130UA-6
C108	10 pF 50WV Ceramic Capacitor	2A	RT-130UA-6
C109	10 pF 50WV Ceramic Capacitor	2A	RT-130UA-6
C110	0.002 $\mu$ F 50WV Ceramic Capacitor	2A	RT-130UA-6
C111	8 pF 50WV Ceramic Capacitor	2A	RT-130UA-6
C112	4 pF 50WV Ceramic Capacitor	2A	RT-130UA-6
C113	12 pF 50WV Ceramic Capacitor	3A	RT-130UA-6
C114	0.01 $\mu$ F 50WV Ceramic Capacitor	2A	RT-130UA-6
C115	0.01 $\mu$ F 50WV Ceramic Capacitor	2A	RT-130UA-6
C116	0.002 $\mu$ F 50WV Ceramic Capacitor	1A	RT-130UA-6
C117	40 pF 50WV Ceramic Capacitor	1A	RT-130UA-6
C118	40 pF 50WV Ceramic Capacitor	1A	RT-130UA-6
C119	0.01 $\mu$ F 50WV Ceramic Capacitor	1A	RT-130UA-6
C120	0.01 $\mu$ F 50WV Ceramic Capacitor	1A	RT-130UA-6
C121	0.01 $\mu$ F 50WV Ceramic Capacitor	1A	RT-130UA-6
C201	0.02 $\mu$ F 25WV $\pm 100\%$ Ceramic Capacitor	3A	TRF-2BA
C202	0.02 $\mu$ F 25WV $\pm 100\%$ Ceramic Capacitor	3A	TRF-2BA
C203	0.02 $\mu$ F 25WV $\pm 100\%$ Ceramic Capacitor	3A	TRF-2BA
C204	0.02 $\mu$ F 25WV $\pm 100\%$ Ceramic Capacitor	3A	TRF-2BA
C205	200 $\mu$ F 10WV RB Electrolytic Capacitor	4A	TRF-2BA
C206	0.02 $\mu$ F 25WV $\pm 100\%$ Ceramic Capacitor	4A	TRF-2BA
C207	0.02 $\mu$ F 25WV $\pm 100\%$ Ceramic Capacitor	4A	TRF-2BA
C208	0.02 $\mu$ F 25WV $\pm 100\%$ Ceramic Capacitor	4A	TRF-2BA
C209	0.02 $\mu$ F 25WV $\pm 10\%$ Ceramic Capacitor	4A	TRF-2BA
C210	0.02 $\mu$ F 25WV $\pm 100\%$ Ceramic Capacitor	4A	TRF-2BA
C211	0.02 $\mu$ F 25WV $\pm 100\%$ Ceramic Capacitor	5A	TRF-2BA
C212	0.02 $\mu$ F 25WV $\pm 100\%$ Ceramic Capacitor	5A	TRF-2BA
C213	200 pF 25WV $\pm 10\%$ Ceramic Capacitor	5A	TRF-2BA
C214	200 pF 25WV $\pm 10\%$ Ceramic Capacitor	5A	TRF-2BA
C215	50 pF 25WV $\pm 10\%$ Ceramic Capacitor	5A	TRF-2BA

A	B	C	D
C216	200 $\mu$ F 10WV RB Electrolytic Capacitor	5A	TRF-2BA
C217	0.02 $\mu$ F 25WV $\pm 100\%$ Ceramic Capacitor	5A	TRF-2BA
C218	5 $\mu$ F 10WV RB Electrolytic Capacitor	5A	TRF-2BA
C219	0.001 $\mu$ F 25WV $\pm 100\%$ Ceramic Capacitor	3A	TRF-2BA
C220	50 pF 25WV $\pm 10\%$ Ceramic Capacitor	3A	TRF-2BA
C221	50 pF 25WV $\pm 10\%$ Ceramic Capacitor	4A	TRF-2BA
C222	50 pF 25WV $\pm 10\%$ Ceramic Capacitor	4A	TRF-2BA
C223	30 pF 25WV $\pm 10\%$ Ceramic Capacitor	5A	TRF-2BA
C224	2 pF 25WV $\pm 0.5pF$ Ceramic Capacitor	3A	TRF-2BA
C225	0.02 $\mu$ F 25WV $\pm 100\%$ Ceramic Capacitor	3A	TRF-2BA
C226	0.02 $\mu$ F 25WV $\pm 100\%$ Ceramic Capacitor	3A	TRF-2BA
C2201	0.02 $\mu$ F 25WV $\pm 100\%$ Ceramic Capacitor	6B	TRS-4A
C2202	0.02 $\mu$ F 25WV $\pm 100\%$ Ceramic Capacitor	6B	TRS-4A
C2203	0.02 $\mu$ F 25WV $\pm 100\%$ Ceramic Capacitor	6B	TRS-4A
C2204	0.02 $\mu$ F 25WV $\pm 100\%$ Ceramic Capacitor	6B	TRS-4A
C2205	0.02 $\mu$ F 25WV $\pm 100\%$ Ceramic Capacitor	6B	TRS-4A
C2206	10 $\mu$ F 15WV RB Electrolytic Capacitor	6B	TRS-4A
C301	0.001 $\mu$ F 25WV $\pm 100\%$ Ceramic Capacitor	2B	TRAM-4A-6
C302	0.02 $\mu$ F 25WV $\pm 100\%$ Ceramic Capacitor	2B	TRAM-4A-6
C303	30 $\mu$ F 10WV RB Electrolytic Capacitor	2B	TRAM-4A-6
C304	0.02 $\mu$ F 25WV $\pm 100\%$ Ceramic Capacitor	2B	TRAM-4A-6
C305	0.005 $\mu$ F 25WV $\pm 20\%$ Ceramic Capacitor	2B	TRAM-4A-6
C306	15 pF 25WV $\pm 10\%$ Ceramic Capacitor	2B	TRAM-4A-6
C307	430 pF 50WV $\pm 5\%$ Mica Capacitor	2B	TRAM-4A-6
C308	10 $\mu$ F 10WV RB Electrolytic Capacitor	3B	TRAM-4A-6
C309	0.02 $\mu$ F 25WV $\pm 100\%$ Ceramic Capacitor	3B	TRAM-4A-6
C310	0.02 $\mu$ F 25WV $\pm 100\%$ Ceramic Capacitor	3B	TRAM-4A-6
C311	0.02 $\mu$ F 25WV $\pm 100\%$ Ceramic Capacitor	4B	TRAM-4A-6
C312	200 $\mu$ F 10WV RB Electrolytic Capacitor	4B	TRAM-4A-6
C313	0.01 $\mu$ F 50WV $\pm 10\%$ Mylar Capacitor	4B	TRAM-4A-6
C314	0.01 $\mu$ F 50WV $\pm 10\%$ Mylar Capacitor	4B	TRAM-4A-6
C315	0.47 $\mu$ F 25WV RB Electrolytic Capacitor	5B	TRAM-4A-6
C316	200 $\mu$ F 10WV RB Electrolytic Capacitor	5B	TRAM-4A-6
C317	0.1 $\mu$ F 50WV $\pm 10\%$ Mylar Capacitor	5B	TRAM-4A-6
C318	2 pF 25WV $\pm 0.5pF$ Ceramic Capacitor	3B	TRAM-4A-6
C319	1 pF 25WV $\pm 0.5pF$ Ceramic Capacitor	4B	TRAM-4A-6
C320	0.005 $\mu$ F 25WV $\pm 20\%$ Ceramic Capacitor	4B	TRAM-4A-6
C321	0.02 $\mu$ F 25WV $\pm 100\%$ Ceramic Capacitor	4B	TRAM-4A-6
C401	10 $\mu$ F 15WV RB Electrolytic Capacitor	1C	TRX-6
C402	50 $\mu$ F 10WV RB Electrolytic Capacitor	1C	TRX-6
C403	10 $\mu$ F 15WV RB Electrolytic Capacitor	1C	TRX-6
C404	30 $\mu$ F 15WV RB Electrolytic Capacitor	1C	TRX-6
C405	5000 pF 50WV $\pm 5\%$ Mica Capacitor	1C	TRX-6
C406	0.05 $\mu$ F 50WV $\pm 10\%$ Mylar Capacitor	2C	TRX-6
C407	6600 pF 50WV $\pm 5\%$ Mica Capacitor	2C	TRX-6
C408	0.47 $\mu$ F 25WV RB Electrolytic Capacitor	2C	TRX-6
C409	0.05 $\mu$ F 50WV $\pm 10\%$ Mylar Capacitor	2C	TRX-6
C410	1700 pF 50WV $\pm 5\%$ Mica Capacitor	3C	TRX-6
C411	0.05 $\mu$ F 50WV $\pm 10\%$ Mylar Capacitor	3C	TRX-6
C412	0.47 $\mu$ F 25WV RB Electrolytic Capacitor	3C	TRX-6
C413	10 $\mu$ F 10WV RB Electrolytic Capacitor	3C	TRX-6
C414	450 pF 250WV $\pm 10\%$ Mica Capacitor	3C	TRX-6
C415	100 pF 25WV $\pm 10\%$ Ceramic Capacitor	3C	TRX-6



A	B	C	D
C416	100 pF 25WV ±10% Ceramic Capacitor	3C	TRX-6
C417	120 pF 250WV ±10% Mica Capacitor	3C	TRX-6
C418	100 pF 25WV ±10% Ceramic Capacitor	4C	TRX-6
C419	100 pF 25WV ±10% Ceramic Capacitor	4C	TRX-6
C420	200 μF 25WV RB Electrolytic Capacitor	5C	TRX-6
C421	0.1 μF 50WV ±10% Mylar Capacitor	4C	TRX-6
C422	0.1 μF 50WV ±10% Mylar Capacitor	4C	TRX-6
C423	100 μF 6WV RB Electrolytic Capacitor	5C	TRX-6
C424	100 μF 6WV RB Electrolytic Capacitor	5C	TRX-6
C425	100 pF 25WV ±10% Ceramic Capacitor	5C	TRX-6
C426	10 μF 15WV RB Electrolytic Capacitor	5C	TRX-6
C427	0.002 μF 25WV ±10% Ceramic Capacitor	5C	TRX-6
C428	10 μF 15WV RB Electrolytic Capacitor	5C	TRX-6
C429	100 pF 25WV ±10% Ceramic Capacitor	5C	TRX-6
C430	100 μF 6WV RB Electrolytic Capacitor	5C	TRX-6
C431	0.47 μF 25WV RB Electrolytic Capacitor	5C	TRX-6
C432	0.47 μF 25WV RB Electrolytic Capacitor	5C	TRX-6
C501	0.1 μF 50WV ±10% Mylar Capacitor	3D	TRI-1A
C502	5000 pF 50WV ±5% Mica Capacitor	4D	TRI-1A
C503	30 μF 15WV RB Electrolytic Capacitor	4D	TRI-1A
C504	10 μF 15WV RB Electrolytic Capacitor	5D	TRI-1A
C505	1 μF 25WV RB Electrolytic Capacitor	4D	TRI-1A
C601	1.5 μF 3WV Tantalum Solid Capacitor	2E	TRHA-6A
C602	150 pF 25WV ±10% Ceramic Capacitor	2E	TRHA-6A
C603	30 μF 10WV RB Electrolytic Capacitor	2E	TRHA-6A
C604	150 pF 25WV ±10% Ceramic Capacitor	2E	TRHA-6A
C605	10 μF 10WV RB Electrolytic Capacitor	2E	TRHA-6A
C606	10 μF 25WV RB Electrolytic Capacitor	2E	TRHA-6A
C607	0.003 μF 50WV ±10% Mylar Capacitor	2F	TRHA-6A
C608	0.01 μF 50WV ±10% Mylar Capacitor	2F	TRHA-6A
C609	0.004 μF 50WV ±10% Mylar Capacitor	2F	TRHA-6A
C611	1.5 μF 3WV Tantalum Solid Capacitor	2F	TRHA-6A
C612	150 μF 25WV ±10% Ceramic Capacitor	2F	TRHA-6A
C613	30 μF 10WV RB Electrolytic Capacitor	2F	TRHA-6A
C614	150 pF 25WV ±10% Ceramic Capacitor	2F	TRHA-6A
C615	10 μF 10WV RB Electrolytic Capacitor	2F	TRHA-6A
C616	10 μF 25WV RB Electrolytic Capacitor	2F	TRHA-6A
C617	0.003 μF 50WV ±10% Mylar Capacitor	2G	TRHA-6A
C618	0.01 μF 50WV ±10% Mylar Capacitor	2G	TRHA-6A
C619	0.004 μF 50WV ±10% Mylar Capacitor	2G	TRHA-6A
C701	3 μF 25WV RB Electrolytic Capacitor	3E	TRM-7A
C702	3 μF 25WV RB Electrolytic Capacitor	3F	TRM-7A
C703	3 μF 25WV RB Electrolytic Capacitor	4E	TRM-7A
C704	3 μF 25WV RB Electrolytic Capacitor	4F	TRM-7A
C705	0.001 μF 50WV ±10% Mylar Capacitor	4E	TRM-7A
C706	0.001 μF 50WV ±10% Mylar Capacitor	4F	TRM-7A
C707	0.01 μF 50WV ±10% Mylar Capacitor	4E	
C708	0.01 μF 50WV ±10% Mylar Capacitor	4F	
C709	350 pF 250WV ±10% Mica Capacitor	4E	3H
C710	350 pF 250WV ±10% Mica Capacitor	4F	3H
C711	0.01 μF 50WV ±10% Mylar Capacitor	4E	4H
C712	0.01 μF 50WV ±10% Mylar Capacitor	4F	4H
C713	0.1 μF 50WV ±10% Mylar Capacitor	4E	4H
C714	0.1 μF 50WV ±10% Mylar Capacitor	4F	4H
C715	3 μF 25WV RB Electrolytic Capacitor	4E	TRM-7A
C716	3 μF 25WV RB Electrolytic Capacitor	4F	TRM-7A
C717	0.006 μF 50WV Mylar Capacitor	4E	5H
C718	0.006 μF 50WV Mylar Capacitor	4F	4H

A	B	C	D
C719	100 μF 6WV RB Electrolytic Capacitor	4E	TRM-7A
C720	100 μF 6WV RB Electrolytic Capacitor	4F	TRM-7A
C721	25 μF 50WV RB Electrolytic Capacitor	5E	TRM-7A
C722	25 μF 50WV RB Electrolytic Capacitor	5F	TRM-7A
C723	10 μF 25WV RB Electrolytic Capacitor	5E	TRM-7A
C724	10 μF 25WV RB Electrolytic Capacitor	5F	TRM-7A
C725	50 μF 25WV RB Electrolytic Capacitor	5E	TRM-7A
C726	50 μF 25WV RB Electrolytic Capacitor	5F	TRM-7A
C727	50 μF 10WV RB Electrolytic Capacitor	5E	TRM-7A
C728	50 μF 10WV RB Electrolytic Capacitor	5F	TRM-7A
C729	250 pF 250WV ±10% Mica Capacitor	5E	TRM-7A
C730	250 pF 250WV ±10% Mica Capacitor	5F	TRM-7A
C731	0.2 μF 250WV ±10% M.P. Capacitor	6E	TRM-7A
C732	0.2 μF 250WV ±10% M.P. Capacitor	6F	TRM-7A
C733	100 pF 25WV ±10% Ceramic Capacitor	5E	TRM-7A
C734	100 pF 25WV ±10% Ceramic Capacitor	5F	TRM-7A
C735	0.01 μF 50WV ±10% Mylar Capacitor	4G	TRM-7A
C801	2000 μF 35WV Lug Electrolytic Capacitor	6E	5D
C802	2000 μF 35WV Lug Electrolytic Capacitor	6F	4D
CR401	38KC Filter & De-emphasis	4C	TRX-6
CR402	38KC Filter & De-emphasis	4C	TRX-6
VR2201	Meter adjust	6B	TRS-4A
VR401	10KΩ(B) MPX Separation adjustment	6C	2D
VR501	50KΩ(B) Stereo indicator adjustment	3D	TRI-1A
VR502	100KΩ(B) Stereo indicator adjustment	3D	TRI-1A
VR701	} 250KΩ(B) Volume control	3E	2H
VR702		3F	2H
VR703	} 125KΩ(BH) Balance control	3E	1H
VR704		3F	1H
VR705	} 100KΩ(A) Treble control	4E	3H
VR706		4F	3H
VR707	} 100KΩ(A) Bass control	4E	4H
VR708		4F	4H
VR709	100KΩ(B) AC Balance adjustment	5E	TRM-7A
VR710	100KΩ(B) AC Balance adjustment	5F	TRM-7A
VR711	200Ω(B) DC Balance adjustment	5E	TRM-7A
VR712	200Ω(B) DC Balance adjustment	5F	TRM-7A
VR713	5KΩ(B) PSC Sensitivity adjustment	4G	TRM-7A
VC101	FM RF tuning	1A	RT-130UA-6
VC102	FM RF tuning	2A	RT-130UA-6
VC103	FM local oscillator	2A	RT-130UA-6
VC301	AM RF tuning	1B	RT-130UA-6
VC302	AM local oscillator	2B	RT-130UA-6
TC101	Trimer condenser	1A	RT-130UA-6
TC102	Trimer condenser	2A	RT-130UA-6
TC103	Trimer condenser	2A	RT-130UA-6
TC301	Trimer condenser	1B	RT-130UA-6
TC302	Trimer condenser	2B	RT-130UA-6
L101	FM Antenna coil	1A	RT-130UA-6
L102	FM RF Tuning coil	2A	RT-130UA-6
L103	FM Local oscillator coil	2A	RT-130UA-6
L201	3.5 μH FM RF Coil	3A	TRF-2BA
L301	AM Antenna coil	1B	1D
L401	MPX SCA Trap coil	3C	TRX-6
L402	MPX SCA Trap coil	3C	TRX-6

# PARTS LIST

**A:** Parts No.  
**B:** Parts Name  
**C:** Position of Parts (Co-ordinates in "SCHEMATIC DIAGRAM OF CIRCUITS")  
**D:** Position of Parts (Co-ordinates in "PARTS LAYOUT" or by name of printed circuit)

A	B	C	D
T001	Power transformer	5G	5C
T101	FM 1st IFT 10.7MC	2A	RT-130UA-6
T201	FM 2nd IFT 10.7MC	3A	TRF-2BA
T202	FM 3rd IFT 10.7MC	4A	TRF-2BA
T203	FM 4th IFT 10.7MC	4A	TRF-2BA
T204	FM Discriminator	10FD-1-B	5A TRF-2BA
T2201	FM tuning 10.7MC	10FS-1-A <sub>1</sub>	6B TRS-4A
T301	AM Local oscillator coil	TMOC-2	2B TRAM-4A-6
T302	AM 1st IFT 455KC	10AD-1-A <sub>1</sub>	3B TRAM-4A-6
T303	AM 1st IFT 455KC	10AD-1-A <sub>2</sub>	3B TRAM-4A-6
T304	AM 2nd IFT 455KC	10AS-1-A <sub>2</sub>	4B TRAM-4A-6
T305	AM 3rd IFT 455KC	10AS-1-A <sub>3</sub>	4B TRAM-4A-6
T401	MPX 19KC Tuning coil	MPT-20A	1C TRX-6
T402	MPX 19KC Tuning coil	MPT-20B	2C TRX-6
T403	MPX 38KC Tuning coil	MPT-20B	3C TRX-6
T501	19KC Tuning coil	MPT-14A	4D TRI-1A
TR101	CT-1500 FM RF AMP.	Si NPN	1A RT-130UA-6
TR102	CT-1500 FM Local oscillator	Si NPN	2A RT-130UA-6
TR103	CT-1500 FM Mixer	Si NPN	2A RT-130UA-6
TR201	2SA234(B) AM 1st IF Amp.	Ge PNP	3A TRF-2BA
TR202	2SA234(B) FM 2nd IF Amp.	Ge PNP	3A TRF-2BA
TR203	2SA234(B) FM 3rd IF Amp.	Ge PNP	4A TRF-2BA
TR204	2SA234(B) FM 4th IF Amp.	Ge PNP	5A TRF-2BA
TR2201	2SC372 (2SC536) DC Amp.	Ge PNP	6B TRS-4A
TR301	2SA102 AM Frequency converter	Ge PNP	2B TRAM-4A-6
TR302	2SA101(X) AM 1st IF Amp.	Ge PNP	3B TRAM-4A-6
TR303	2SA101(Y) AM 2nd IF Amp.	Ge PNP	4B TRAM-4A-6
TR401	2SA49 M.P.X Amp.	Ge PNP	1C TRX-6
TR402	2SB54 19KC Amp.	Ge PNP	2C TRX-6
TR403	2SA49 38KC Amp.	Ge PNP	3C TRX-6
TR404	2SC536 Differential Amp.	Si NPN	5C TRX-6
TR405	2SC536 Differential Amp.	Si NPN	5C TRX-6
TR406	2SC536 Differential Amp.	Si NPN	5C TRX-6
TR407	2SC536 Differential Amp.	Si NPN	5C TRX-6
TR501	2SC458 19KC Amp.	Si NPN	4D TRI-1A
TR502	2SC458 D.C. Amp.	Si NPN	4D TRI-1A
TR503	2SB54 D.C. Amp.	Ge PNP	5D TRI-1A
TR504	2SC458 Stereo Auto	Si NPN	5D TRI-1A
TR505	2SC324 D.C. Amp.	Ge PNP	5D TRI-1A
TR601	2SC650 Equalizer Amp.	Si NPN	2 F JRHA-6A
TR602	2SC281 Equalizer Amp.	Si NPN	2 F TRHA-6A
TR603	2SC650 Equalizer Amp.	Si NPN	2 E TRHA-6A
TR604	2SC281 Equalizer Amp.	Si NPN	2 E TRHA-6A
TR701	2SC536 Audio Amp.	Si NPN	3 F TRM-7A
TR702	2SC536 Audio Amp.	Si NPN	3 F TRM-7A
TR703	2SC693 Audio Amp.	Si NPN	4 E TRM-7A
TR704	2SC693 Audio Amp.	Si NPN	4 F TRM-7A
TR705	2SC538A Driver Amp.	Si NPN	5 E TRM-7A
TR706	2SC538A Driver Amp.	Si NPN	5 F TRM-7A
TR707	2SC281	Si NPN	5 E TRM-7A
TR708	2SB89A	Ge PNP	5 E TRM-7A
TR709	2SC281	Si NPN	5 F TRM-7A
TR710	2SB89A	Ge PNP	5 F TRM-7A
TR801	2SC244 Power Amp.	Si NPN	5 E 4D
TR802	2SC244 Power Amp.	Si NPN	5 E 5D
TR803	2SC244 Power Amp.	Si NPN	5 F 4D
TR804	2SC244 Power Amp.	Si NPN	5 F 3D
TR905	2SC458 Protector	Si NPN	
D001	SW-1a(IS-1062)	Si Diode	5G 4G
D002	SW-1a(IS-1062)	Si Diode	5G 5G
D003	SW-05-02	Si Diode	5G 5G
D004	SW-05-02	Si Diode	6G 5G
D101	FM AFC		2A RT-130UA-6
D203	OA91 FM Detector	Ge Diode	5A TRF-2BA
D204	OA91 FM Detector	Ge Diode	5A TRF-2BA
D2201	IN60 or MA790	Ge Diode	6B TRS-4A
D2202	IN60 or MA790	Ge Diode	6B TRS-4A
D301	IN60 AGC	Ge Diode	3B TRAM-4A-6
D302	OA79 AM Detector	Ge Diode	4B TRAM-4A-6
D303	IN60	Ge Diode	4B TRAM-4A-6
D401	IN60 19KC Doubler	Ge Diode	2C TRX-6
D402	IN60 19KC Doubler	Ge Diode	2C TRX-6
D403	OA79 Switching	Ge Diode	3C TRX-6
D404	OA79 Switching	Ge Diode	3C TRX-6
D405	OA79 Switching	Ge Diode	3C TRX-6
D406	OA79 Switching	Ge Diode	3C TRX-6
D501	IN60	Ge Diode	4D TRI-1A
D502	SM-150-01	Si Diode	5D TRI-1A
D503	IN60	Ge Diode	5D TRI-1A
D701	IS180	Si Diode	5 E TRM-7A
D702	IS180	Si Diode	5 E TRM-7A
D703	IS180	Si Diode	5 F TRM-7A
D704	IS180	Si Diode	5 F TRM-7A
D705	IN60	Ge Diode	4G TRM-7A
D706	IN60	Ge Diode	4G TRM-7A
SCR701	V-312B		3G TRM-7A
TH501	D-22A		4D TRI-1A
S001	Power switch		4G 5H
S1a, b	Function switch	Y-6-11-6	1A
S2a, b	Mode switch		3E, 3F 3H
S3a, b	Tape Monitor switch		3E, 3F 2H
S4a, b	Loudness switch		3E, 3F 2H
S5a, b	Noise filter switch		4E, 4F 4H
S6a, b	Speaker selector switch		4E, 4F 5H
S7a, b	Antenna switch		1B 1D
PL001	Pilot Lamp Fuse type	6.3V 0.3A	5G 2A
PL002	Pilot Lamp Fuse type	6.3V 0.3A	5G 5A
PL003	Meter Indicator Lamp	8V 0.15A	6G 5A
PL501	FM Stereo Indicator Lamp	8V 0.15A	6D 5A
PL901	Protector Indicator Lamp	25V 0.09A	4G 2A
F001	Fuse Tubular	2A	4G 4E
F003	Super-quick fuse	1.5A	5G 4B
F004	Super-quick fuse	1.5A	5G 4B
PU001	Voltage selector plug(100, 117, 220, 240V)		4G 4C
CO001	AC Outlet MAX 30VA		4G 5E
M	Tuning meter (100μA)		4A 5A

# COLOR CODE

The color code indicates 10 different colors by the help of the figures of 1 to 9. This code agrees with IEC and JIS.

Color	Common to All Parts			Fixed Resistor Allowance (%)	Mica Capacitor				Paper Capacitor		Ceramic Capacitor			
	1st Figure	2nd Figure	Multiplier		Grade	Pro- perty	Allow- ance (%)	Rated Voltage (V)	Allow- ance (%)	Rated Voltage (V)	Grade	Pro- perty	Allow- ance (%)	Rated Voltage (V)
black	0	0	1		X	A	±20(M)		±20(M)	100	X		±20	
brown	1	1	10 <sup>1</sup>			B			±5(J)	200				
red	2	2	10 <sup>2</sup>	±2	Z	C	±2(G)		±2(G)	250	Z			250
orange	3	3	10 <sup>3</sup>			D		300						
yellow	4	4	10 <sup>4</sup>			E			±15(L)	400				
green	5	5	10 <sup>5</sup>			F	±5(J)	500	+20(V) -15(V)					500
blue	6	6	10 <sup>6</sup>						+40(X) -15(X)	600			+100 0	
purple	7	7	10 <sup>7</sup>								(Y)			
grey	8	8	10 <sup>8</sup>		Y				+10(Y) -25(Y)					
white	9	9	10 <sup>9</sup>					1000	±10(K)	1000				
golden			10 <sup>-1</sup>	±5										
silver			10 <sup>-2</sup>	±10							YY YZ			
non-colored				±20										

Note	<p>Carbon Resistor</p>			
------	------------------------	--	--	--

Property	Temperature Coefficient	Divergence of Capacity	Q tan δ	Insulation Resistance	Grade	Usable Temperature Range	Test Classification	Letter	Allowance
A	Not specified	Not specified	0.5 under	3000MΩ under	X	-55~+85	I or II	G	±2
B	Not specified	Not specified	0.5 over	7500MΩ over but 0.1 over 3000MΩ over	Y	-30~+85	I or II	J	±5
C	-20~+200	±(0.5%+0.5pF)			Z	-30~+85	I	K	±10
D	-100~+100	±(0.3%+0.1pF)						M	±20
E	-20~+100	±(0.1%+0.1pF)							
F	0~+70	±(0.05%+0.1pF)							



*Sansui*<sup>®</sup>

SANSUI ELECTRIC COMPANY LIMITED

Head Office: 14-1, 2-chome, Izumi, Suginami-ku, Tokyo, Japan. TEL. 328-0111

Printed in Japan (O7030M3)